

TCL

S4510

5.1 Channel Sound Bar with Dolby Audio™, DTS® Virtual:X™,
Wireless Subwoofer and Wired Surround Sound Speakers

Quick Start Guide



1

Register Your Product

Register your TCL Sound Bar to receive the latest news on product releases, promotional offers, and more!*

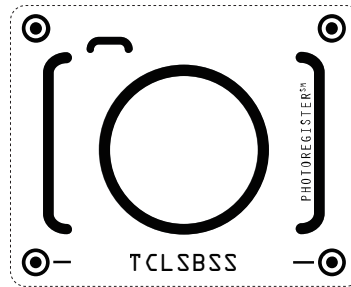

Text to Register
Text a photo of the
camera icon to 71403

Or register online at register.tcl.com

Need help? Visit photoregister.com/help
or text HELP to 71403

Enjoy exclusive benefits with registration:



Expedited support and service



Insider tips on your sound bar



Exclusive offers and promotions



Verification of ownership

*Only Available to U.S. Customers

2

What's in the box

Make sure you read all the safety information before you use this product.

User Manual can be found at www.tcl.com/us on the specific product page in the "Download" section.



Warning:

To avoid the danger of suffocation, keep plastic packaging away from pets, babies, and children. Do not use packaging bags in cribs, beds, carriages, or playpens.



Sound bar



Subwoofer



Surround Sound Speakers
(Cable length: 26 ft. 2.96")



Power cord x 2
(Cable length: 4 ft. 11")



HDMI cable
(Cable length: 4 ft. 11")



IR pass-through cable
(Cable length: 9.8")

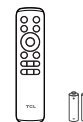

Remote control
AAA battery x 2

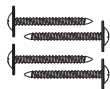

Screw x 4
(for installing the wall mount brackets)

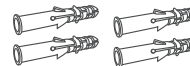

Wall anchor x 4

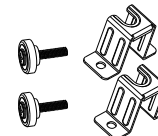

Wall mount screw x 2
Wall mount bracket x 2

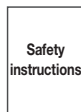

Safety leaflet

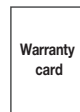

Warranty card

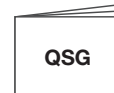

Quick Start Guide



Wall mount template

- ❶ AC input power connector
- ❷ AUX VA input connector
- ❸ AUX input connector
- ❹ IR input connector
- ❺ USB Type A connector
- ❻ Optical input connector
- ❼ HDMI ARC connector

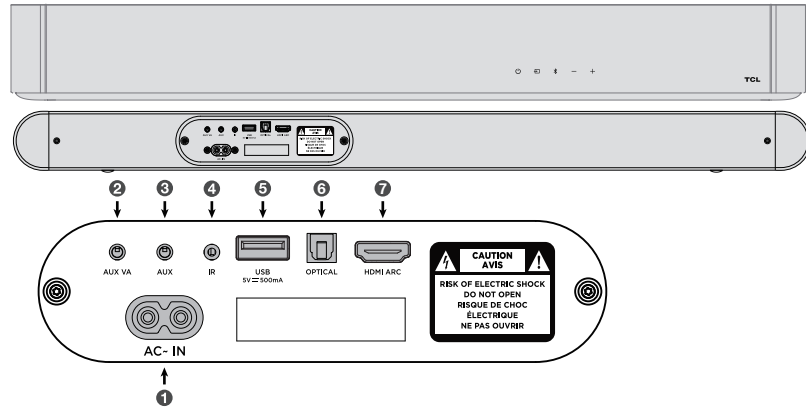

Source button:

Short press: Switch input sources
(HDMI-ARC/Optical/AUX/AUX VA/USB/Bluetooth)
Long press: Enter subwoofer pairing
(If subwoofer disconnected)

Volume buttons:

Press to increase or decrease the volume level.



Power button:

Short Press: Power On/Sleep
Long Press: Power Off

Bluetooth button:

Short Press: Select Bluetooth mode
Long press: Bluetooth Pairing

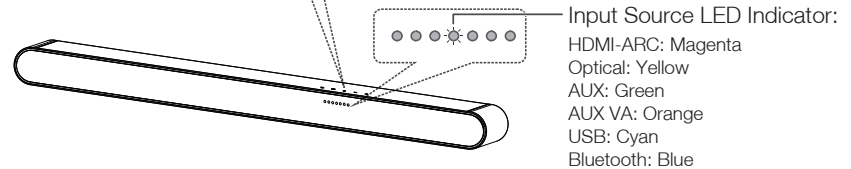

Input Source LED Indicator:



HDMI-ARC: Magenta
Optical: Yellow
AUX: Green
AUX VA: Orange
USB: Cyan
Bluetooth: Blue

3b

Overview

Wireless subwoofer

The subwoofer will pair automatically with sound bar upon first use. In case of a problem, take the following steps to manually pair:

1. Press and hold the  button on the subwoofer for 3 seconds until an amber light begins flashing above the pair button.
2. Press and hold the  button on the sound bar until a yellow LED indicator flashes on the sound bar. After a short while, the sound bar LED will turn green and the subwoofer LED will turn solid.
3. The subwoofer is now connected to the sound bar.

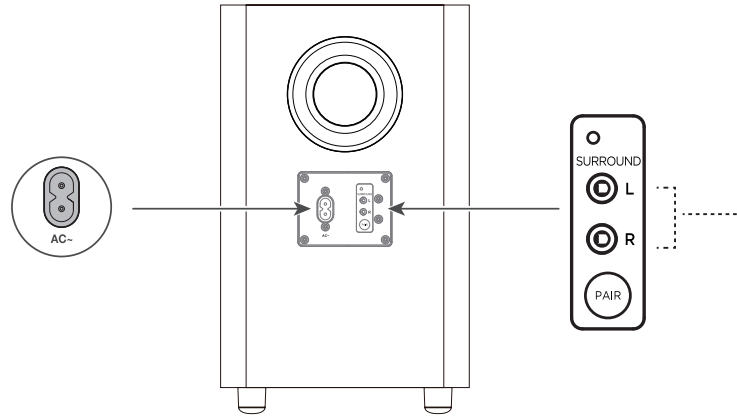

3c

Overview

Surround Sound Speakers

1. Connect each surround sound speaker into one of the surround ports on the back of the subwoofer.

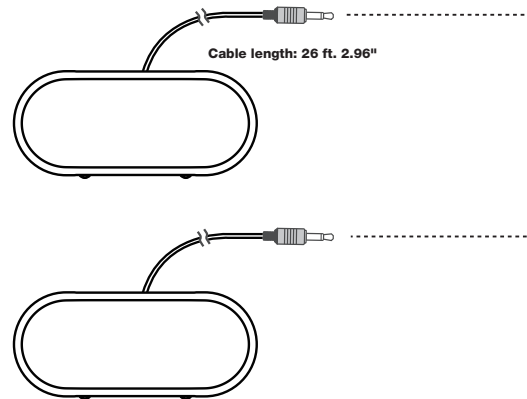

4a

Install or replace the remote batteries

Battery type: 1.5V AAA battery x 2

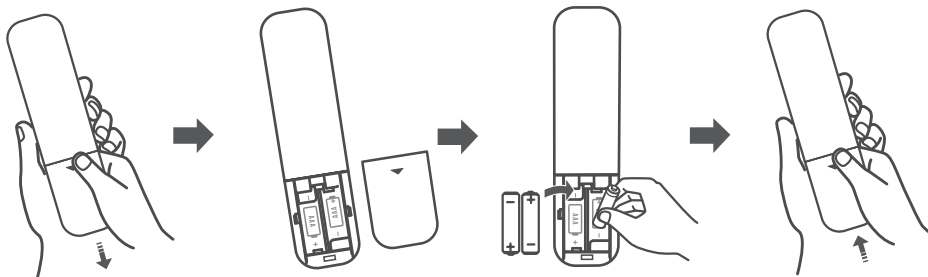

4b

Use the Remote



Warning: Do not expose batteries to excessive heat such as sunshine, fire, or the like. Keep new and used batteries away from children. For disposal or recycling information, please contact your local authorities.



CAUTION: Danger of explosion if the battery is incorrectly replaced. Replace only with the same or equivalent type.

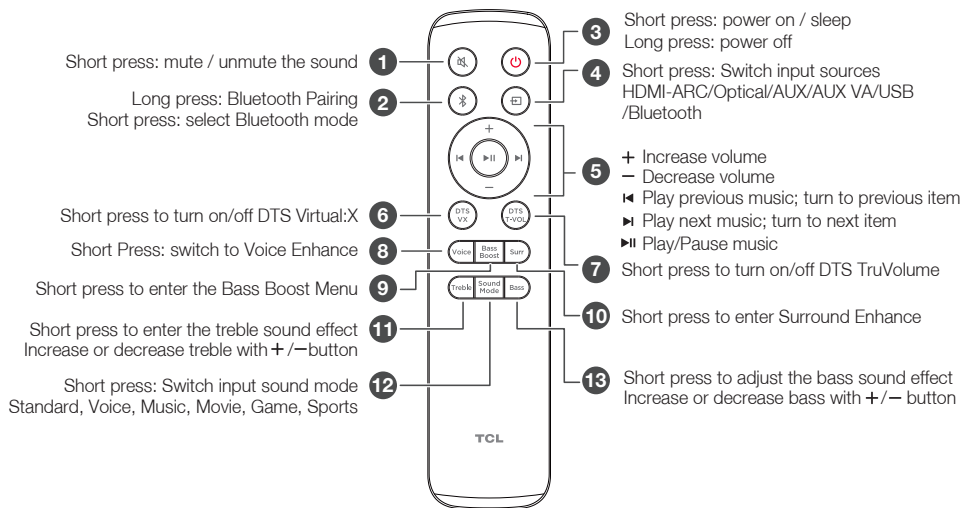

5

Sound Bar LED Display

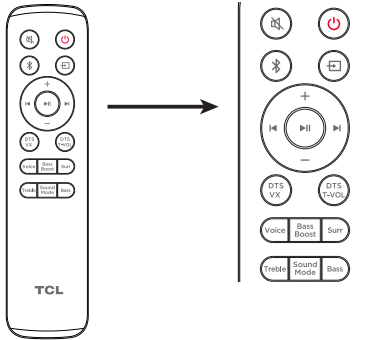



Remote Control	Sound bar Action	LED Behavior on Sound bar
	Power off/Sleep Power On	Power Off: All LEDs light turn on and turn off from the sides to the center. Power On: LEDs will turn on from the center to the sides.
	Mute sound	Mute On: Center LED will flash several times. Mute Off: Current Volume Level will be shown.
	Source	Input Source LED Indicator: HDMI ARC: Magenta Optical: Yellow Aux: Green Aux VA: Orange USB: Cyan Bluetooth: Blue
	Bluetooth Pairing	Blue LED will flash rapidly
	Volume up/down	Volume Up: LEDs will gradually turn on from the center to the sides Volume Down: LEDs will gradually turn off from the sides to the center
	Skip/Previous	Skip: LEDs move from the left to the right Previous: LEDs move from the right to the left
	DTS Virtual:X/TruVolume	Enabled: LEDs will turn on from the center to the sides. Disabled: All LEDs light turn on and turn off from the sides to the center.
	Voice Enhance	Long Press: Enter Voice Enhance adjustment Use UP/DOWN keys to adjust between four different levels. Short Press: Show current Voice Enhance level Use UP/DOWN keys to adjust between four different levels.
	Bass Boost / Night	Long Press: Enable/Disable Night mode with voice broadcast Short Press: Show current Bass Boost level Use UP/DOWN keys to adjust between four different levels.
	Surround Enhance	Short Press: Show current Surround Enhance level Use UP/DOWN keys to adjust between four different levels. Long Press: Turn on or turn off AUX voice assistant.
	Treble Adjustment	Short Press: Show current Treble level. Increase/Decrease using UP/DOWN keys to adjust thirteen different levels.
	Sound Mode	Press to switch sound mode in following order: Standard / Voice / Music / Movie / Game / Sports
	Bass Adjustment	Short Press: Show current Bass level. Increase/Decrease using UP/DOWN keys to adjust thirteen different levels.

6a

Place your Sound Bar and Subwoofer

The ideal place to position the Sound Bar is centered underneath your TV.

 Note: Do not place your sound bar in a location exposed to direct sunlight, heat, fire, or moisture.

 Note: It's recommended to keep the distance within 9.8 feet between the Surround Sound Speakers and the sound bar.

Top View

Sound Bar on the table

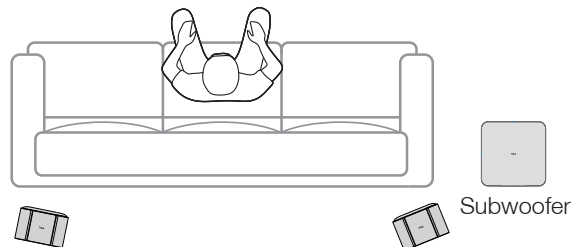

Surround Sound Speaker on the left

Surround Sound Speaker on the right

6b

Wall mount your Sound Bar

Required tools:

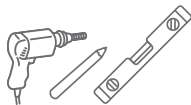

- 1 Place the included wall mount template on the wall. Make sure the wall mount template is at least 2 inches below the center of the TV.
- 2 Use a level to make sure the wall mount template is positioned accurately
- 3 Use the tape to stick the wall mount template firmly on the wall.
- 4 Mark on the wall using each marking on the template through the mounting holes.
- 5 Take away the wall mount template.
- 6 Drill screw holes at each marking on the wall.

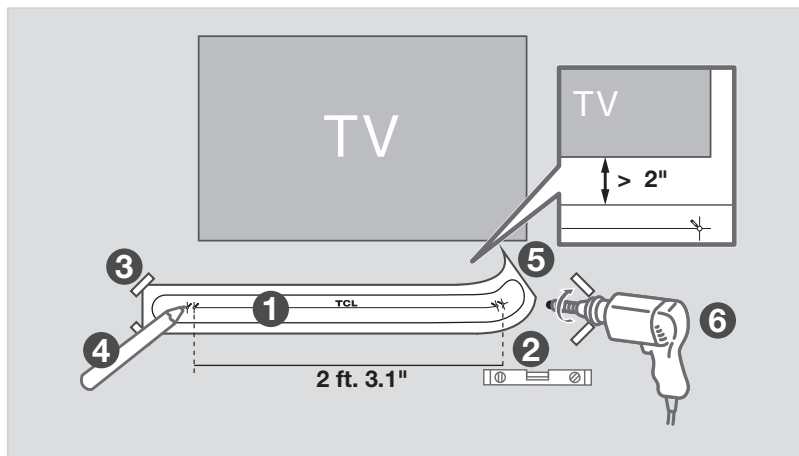

6b

Wall mount your Sound Bar

Required tools:



- 7 Insert the wall anchors in the holes on the wall.
- 8 Insert the included screws with the brackets into the hole of the wall anchors.
- 9 Fix and tighten the wall brackets and screws on the sound bar.
- 10 Replace the screws with the included long wall mount screws.
- 11 Pick up the sound bar and attach it to the brackets, similar to how you would hang a picture. Make sure everything is tight.



Note:

Do not place your sound bar in a location exposed to direct sunlight, heat, fire, or moisture. Only suitable for mounting at heights: < 6 ft. 6.7"

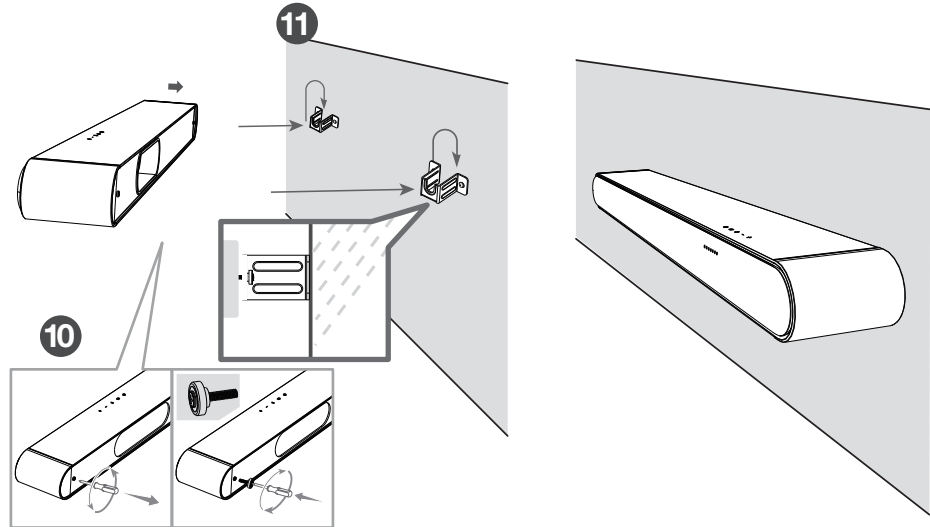
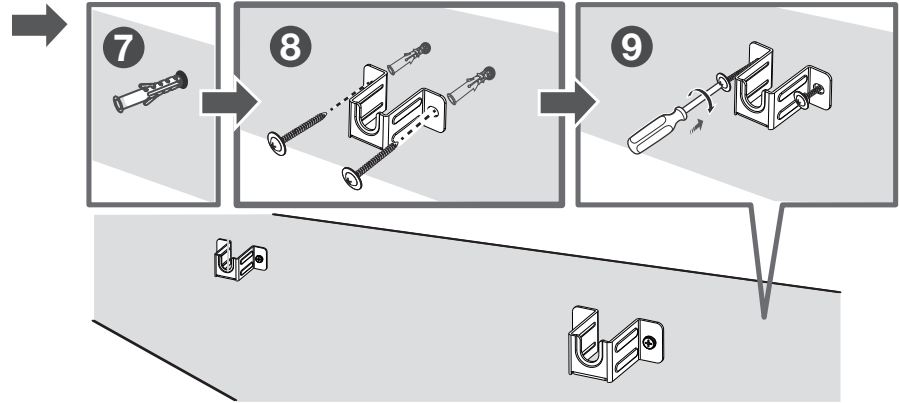

6c

Wall mount Your Surround Sound Speakers

Notes: Only suitable for mounting at heights: < 6 ft. 6.7".
Wall-mount bracket is not included.

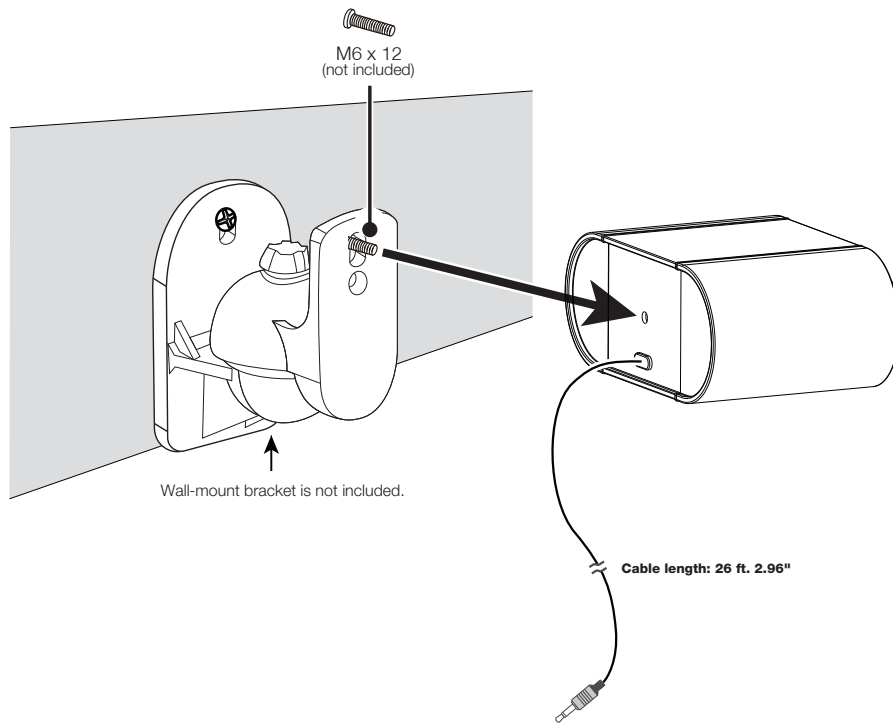

7

Connect to your TV

There are 2 ways to connect your sound bar to the TV (listed in order that we recommend): HDMI ARC (refer to 7a), and Optical (refer to 7b).

If you have a Roku TV™, simply plug in the HDMI cable to the ARC ports and follow the Roku TV Ready™ on-screen instructions.



- ✓ Simple setup
- ✓ One remote
- ✓ Quick settings

7a

HDMI-ARC

Connect the Sound Bar to your TV with the included HDMI cable.

Connect the Sound Bar to the power outlet with the included power cord.

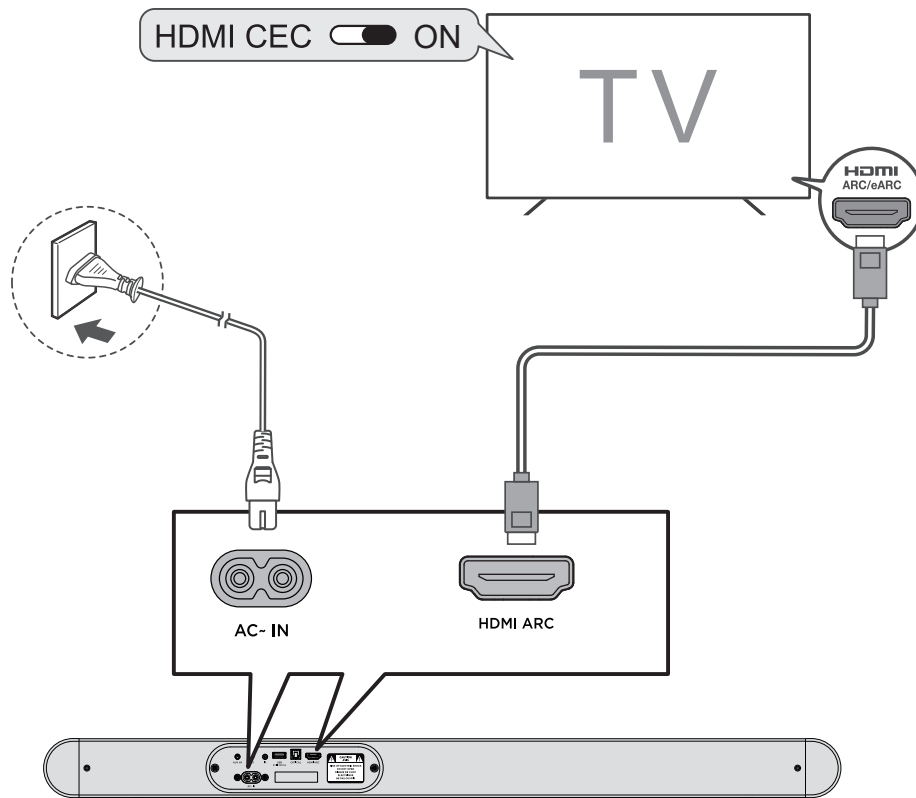

7a

HDMI-ARC

Enable CEC function on TCL TV.

- 1 Connect HDMI cable from the HDMI (ARC) interface on the sound bar to the HDMI (ARC/eARC) interface on the TV.
- 2 Enable the CEC function in the settings of the TCL TV.
(See TV User Manual for instructions)

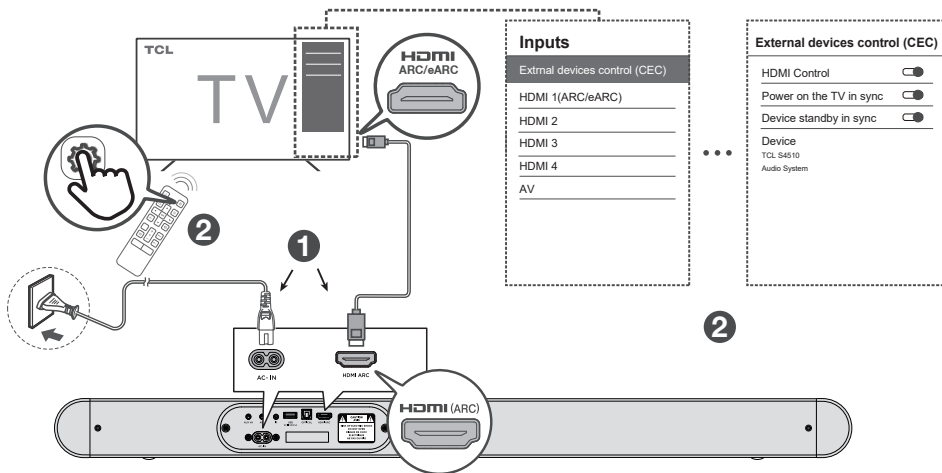

Enable CEC function on other brand TV.

- 1 Connect HDMI cable from the HDMI (ARC) interface on the sound bar to the HDMI (ARC/eARC) interface on the TV.
- 2 Enable the CEC function in the settings of the TV.



Note:
CEC (Consumer Electronic Control) function naming may differ by TV manufacturer. This feature may be called CEC, Anynet+, SimpLink, BRAVIA Link, EasyLink or VIERA Link. Please see your TV's user manual for more information.

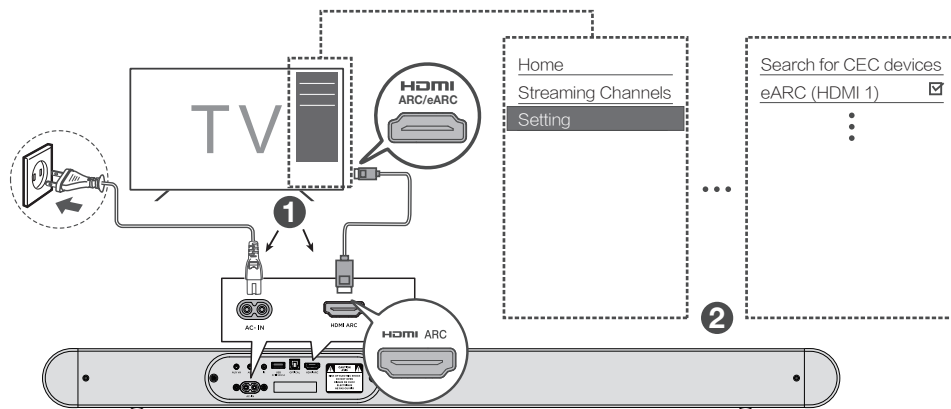

7b

Optical

Connect the Sound Bar to the TV with an Optical cable.

Connect the Sound Bar to the power outlet with the included power cord.





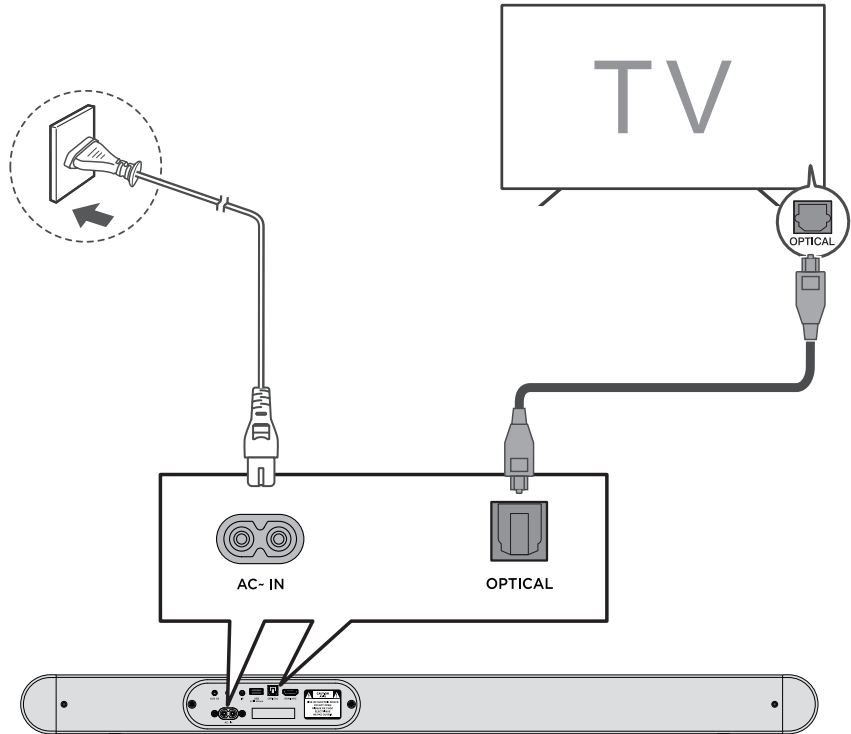

Warning:
Do not bend or kink the optical cable (SPDIF) as it is fragile and can easily get damaged and broken.



8

Pair with your Bluetooth device

You can stream music from your mobile device via Bluetooth.

1. Press .
2. Press .
3. Press and hold  on the remote control or press and hold  on your sound bar.
 - > You will see blue LEDs flashing rapidly.
 - > The Sound Bar is ready to pair.
4. Power on your Bluetooth device and activate its Bluetooth function.
 - > You will see the blue light on for 3 seconds.
 - > Pairing is successful.
5. Select **TCL S4510**.
 - > You will see the blue light on for 3 seconds.
 - > Pairing is successful.
6. If you want to pair another device, please repeat step 3.

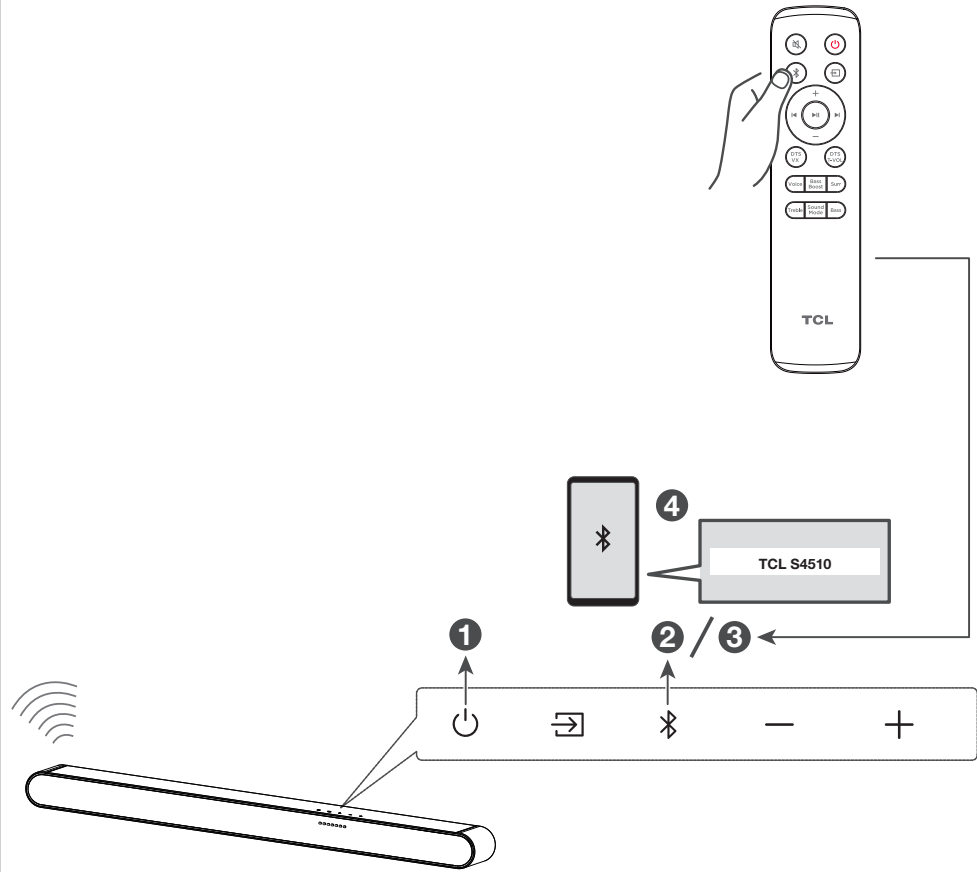

9a

Other connections - USB

Supported audio files: MP3, WMA, FLAC, WAV.

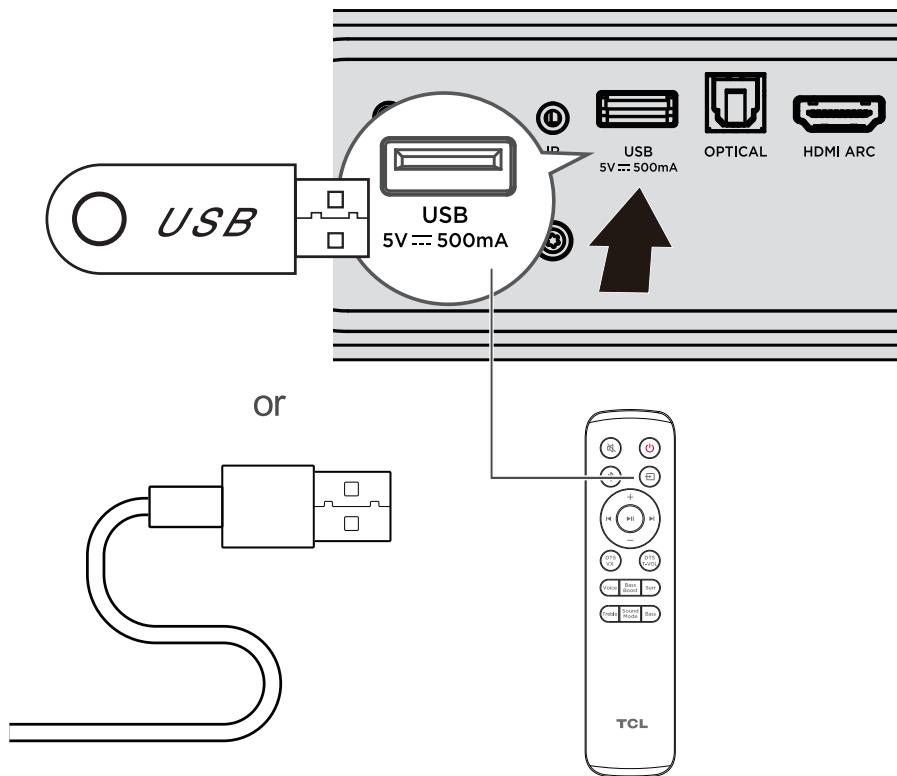

9b

Other connections - AUX

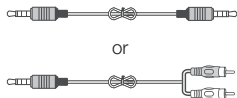

Cables are not included.

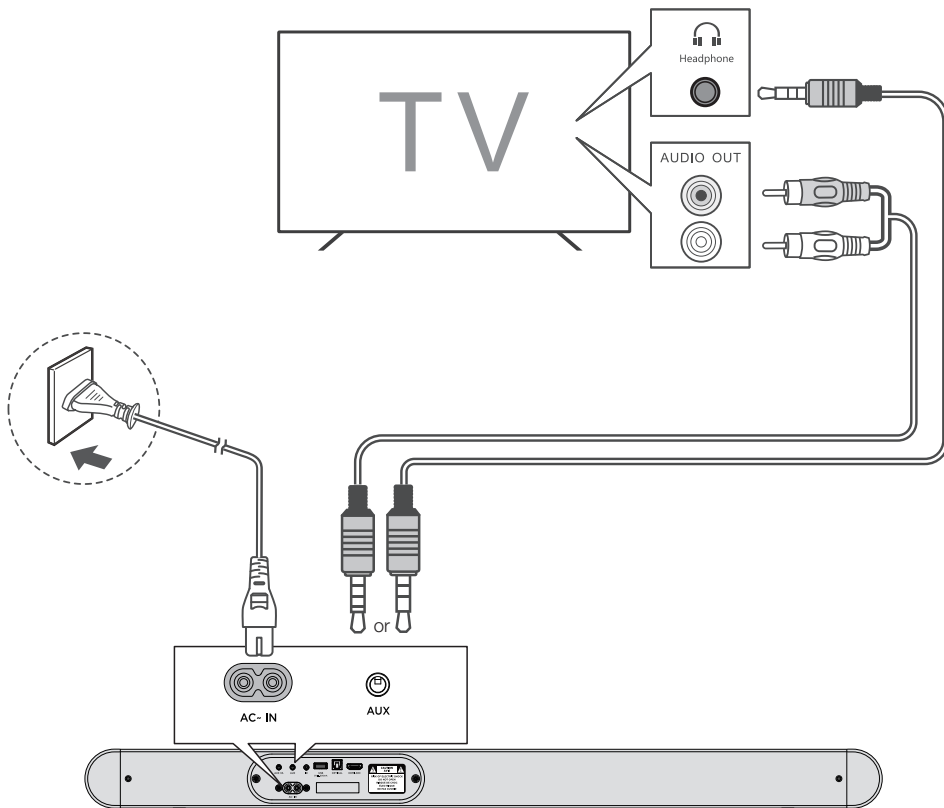

9c

Other connections
- AUX VA

Your sound bar can connect to a **Voice Assistant (VA)** device through an AUX VA connection. Once connected, your sound bar will now act as the VA speaker.

Features and Benefits:

- **Voice Assistant Dedicated Input:** VA is active on the sound bar even if the sound bar is set to a different input with audio playing.
- **Auto Muting:** If playing audio from the sound bar, the VA will play over the original source audio for 10 seconds. If continued after the 10 seconds, the VA audio will mute the original source audio. Once the VA audio is stopped the original source audio will resume.
- If you wish to disable Aux VA features, you can long press  button. Now you can use the Aux VA port as a standard Aux port for additional connections.

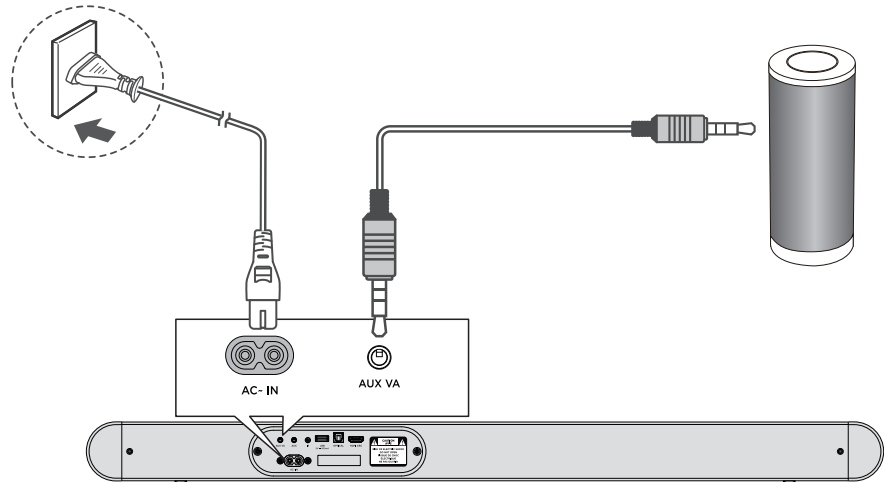

10 IR Pass-through



If the sound bar blocks the IR receiver of the TV when placed directly in front of it. You can use the included IR pass-through cable to send IR commands to your TV using the sound bar. First connect one end of the IR pass-through cable to the IR connector on your sound bar. Next, place the other end with the IR blaster close to the TV's IR receiver.

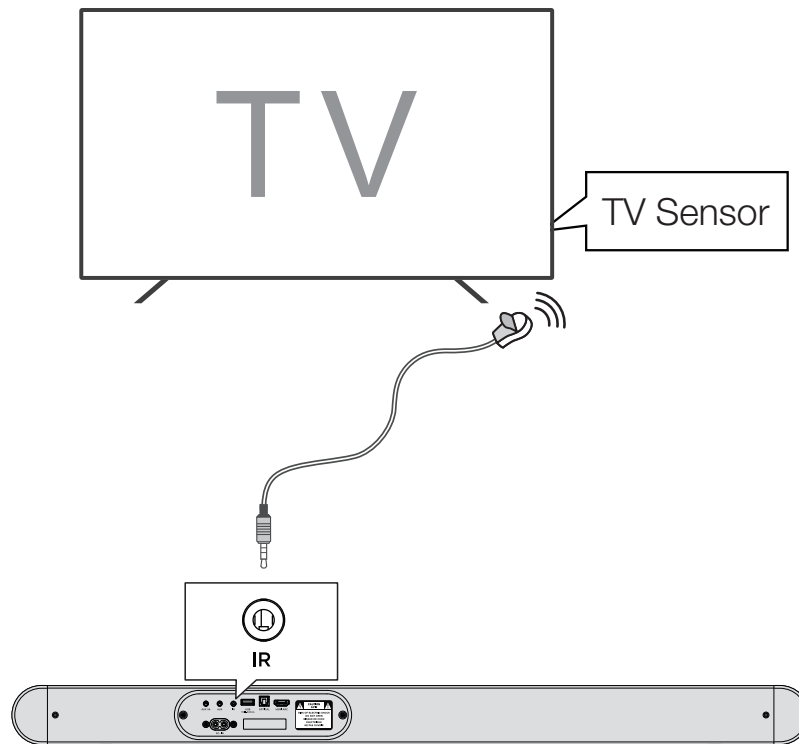

Trademarks



Roku, the Roku logo, Roku TV, Roku TV Ready, and the Roku TV Ready logo are trademarks and/or registered trademarks of Roku, Inc. This product is Roku TV Ready-supported in the United States. Countries are subject to change. For the most current list of countries in which this product is Roku TV Ready-supported, please email rokutvready@roku.com.



Manufactured under license from Dolby Laboratories. Dolby, Dolby Audio, and the double-D symbol are trademarks of Dolby Laboratories Licensing Corporation.



The Bluetooth® word mark and logos are registered trademarks owned by Bluetooth SIG, Inc. and any use of such marks by TTE Corporation is under license. Other trademarks and trade names are those of their respective owners.



For DTS patents, see <http://patents.dts.com>. Manufactured under license from DTS, Inc. DTS, Digital Surround, Virtual:X, and the DTS logo are registered trademarks or trademarks of DTS, Inc. in the United States and other countries.

© 2022 DTS, Inc. ALL RIGHTS RESERVED.



"The terms HDMI, HDMI High-Definition Multimedia Interface, HDMI trade dress and the HDMI Logos are trademarks or registered trademarks of HDMI Licensing Administrator, Inc."

DO NOT RETURN TO STORE

**WE ARE
READY TO
HELP** contact us first
with any questions



TCL SUPPORT:
support.tcl.com
1-877-300-9223



**TAKE CARE WHEN
REMOVING THE SOUND BAR**