

**SMART SOUNDBAR 300**

**Please read and keep all safety, security, and use instructions.**

**CE** Bose Corporation hereby declares that this product is in compliance with the essential requirements and other relevant provisions of Directive 2014/53/EU and all other applicable EU directive requirements. The complete declaration of conformity can be found at: [www.Bose.com/compliance](http://www.Bose.com/compliance)

**UK CA** This product conforms to all applicable Electromagnetic Compatibility Regulations 2016 and all other applicable UK regulations. The complete declaration of conformity can be found at: [www.Bose.com/compliance](http://www.Bose.com/compliance)

Bose Corporation hereby declares that this product is in compliance with the essential requirements per Radio Equipment Regulations 2017 and all other applicable UK regulations. The complete declaration of conformity can be found at: [www.Bose.com/compliance](http://www.Bose.com/compliance)

**Important Safety Instructions**

1. Read these instructions.
2. Keep these instructions.
3. Heed all warnings.
4. Follow all instructions.
5. Do not use this apparatus near water.
6. Clean only with a dry cloth.
7. Do not block any ventilation openings. Install in accordance with the manufacturer’s instructions.
8. Do not install near any heat sources such as radiators, heat registers, stoves, or other apparatus (including amplifiers) that produce heat.
9. Only use attachments/accessories specified by the manufacturer.
10.  Use only with the cart, stand, tripod, bracket, or table specified by the manufacturer, or sold with the apparatus. When a cart is used, use caution when moving the cart/apparatus combination to avoid injury from tip-over.
11. Unplug this apparatus during lightning storms or when unused for long periods of time.
12. Refer all servicing to qualified personnel. Servicing is required when the apparatus has been damaged in any way, such as power-supply cord or plug is damaged, liquid has been spilled or objects have fallen into the apparatus, the apparatus has been exposed to rain or moisture, does not operate normally, or has been dropped.

**WARNINGS/CAUTIONS**

 This symbol on the product means there is uninsulated, dangerous voltage within the product enclosure that may present a risk of electrical shock.

 This symbol on the product means there are important operating and maintenance instructions in this guide.

 Do not ingest battery, chemical burn hazard. The remote control supplied with this product contains a coin/button cell battery. If the coin/button cell battery is swallowed, it can cause severe internal burns in just 2 hours and can lead to death. Keep new and used batteries away from children. If the battery compartment does not close securely, stop using the remote control and keep it away from children. If you think batteries might have been swallowed or placed inside any part of the body, seek immediate medical attention. To avoid risk of explosion, fire or chemical burn, use caution in replacing the battery and replace only with an agency approved (e.g., UL) CR2032 or DL2032 3-volt lithium battery. Properly and promptly dispose of used batteries. Do not recharge, disassemble, heat above 212° F (100° C) or incinerate.



Contains small parts which may be a choking hazard. Not suitable for children under age 3.



This product contains magnetic material. Consult your physician on whether this might affect your implantable medical device.

- To reduce the risk of fire or electrical shock, do NOT expose this product to rain, liquids or moisture.
- Do NOT expose this product to dripping or splashing, and do not place objects filled with liquids, such as vases, on or near the product.
- Keep the product away from fire and heat sources. Do NOT place naked flame sources, such as lighted candles, on or near the product.
- Do NOT make unauthorized alterations to this product.
- Do NOT use a power inverter with this product.
- The speaker wire and interconnect cables included with this system are not approved for in-wall installation. Please check your local building codes for the correct type of wire and cable required for in-wall installation.
- Where the mains plug or an appliance coupler is used as the disconnect device, the disconnect device shall remain readily operable.



仅适用于 2000m 以下地区安全使用  
Use at altitude less than 2000 meters only.

- The battery provided with this product may present a risk of fire, explosion or chemical burn if mishandled, incorrectly replaced or replaced with an incorrect type.
- Only use the following hardware to mount this product: Bose Soundbar Wall Bracket.
- Do not mount on surfaces that are not sturdy, or that have hazards concealed behind them, such as electrical wiring or plumbing. If you are not sure about installing the bracket, contact a qualified professional installer. Ensure the bracket is installed according to local building codes.
- Due to ventilation requirements, Bose does not recommend placing the product in a confined space such as in a wall cavity or in an enclosed cabinet.
- Do not place or install the bracket or product near any heat sources, such as fireplaces, radiators, heat registers or other apparatus (including amplifiers) that produce heat.
- The product label is located on the back of the soundbar.

**NOTE:** This equipment has been tested and found to comply with the limits for a Class B digital device, pursuant to Part 15 of the FCC Rules. These limits are designed to provide reasonable protection against harmful interference in a residential installation. This equipment generates, uses, and can radiate radio frequency energy and, if not installed and used in accordance with the instructions, may cause harmful interference to radio communications. However, there is no guarantee that interference will not occur in a particular installation. If this equipment does cause harmful interference to radio or television reception, which can be determined by turning the equipment off and on, the user is encouraged to try to correct the interference by one or more of the following measures:

- Reorient or relocate the receiving antenna.
- Increase the separation between the equipment and receiver.
- Connect the equipment into an outlet on a circuit different from that to which the receiver is connected.
- Consult the dealer or an experienced radio/TV technician for help.

Changes or modifications not expressly approved by Bose Corporation could void the user's authority to operate this equipment.

This device complies with part 15 of the FCC Rules and with ISED Canada license-exempt RSS standard(s). Operation is subject to the following two conditions: (1) This device may not cause harmful interference, and (2) this device must accept any interference received, including interference that may cause undesired operation.

This equipment should be installed and operated with a minimum distance of 20 cm between radiator and your body.

This device for operation in the band 5150 – 5250 MHz is only for indoor use to reduce the potential for harmful interference to other co-channel mobile satellite systems.

**CAN ICES-3(B)/NMB-3(B)**

**For Europe:**

Frequency bands of operation 2400 to 2483.5 MHz, 5150 to 5350 MHz, and 5470 to 5725 MHz.

Maximum transmit power less than 20 dBm EIRP.

Frequency band of operation 5725 to 5850 MHz.

Maximum transmit power less than 14 dBm (25mW) EIRP.

Maximum transmit power is below regulatory limits such that SAR testing is not necessary and exempt per applicable regulations.

This device is restricted to indoor use when operating in the 5150 to 5350 MHz frequency range in all EU Member States listed in the table.

									
BE	DK	IE	UK(NI)	FR	CY	SK	HU	AT	SE
BG	DE	PT	EL	HR	LV	LT	MT	PL	
CZ	EE	FI	ES	IT	RO	LU	NL	SI	



This symbol means the product must not be discarded as household waste, and should be delivered to an appropriate collection facility for recycling. Proper disposal and recycling helps protect natural resources, human health and the environment. For more information on disposal and recycling of this product, contact your local municipality, disposal service, or the shop where you bought this product.

## Management Regulation for Low-power Radio-frequency Devices

### Article XII

According to “Management Regulation for Low-power Radio-frequency Devices” without permission granted by the NCC, any company, enterprise, or user is not allowed to change frequency, enhance transmitting power or alter original characteristic as well as performance to an approved low power radio-frequency devices.

### Article XIV

The low power radio-frequency devices shall not influence aircraft security and interfere legal communications; If found, the user shall cease operating immediately until no interference is achieved. The said legal communications means radio communications operated in compliance with the Telecommunications Act.

The low power radio-frequency devices must be susceptible with the interference from legal communications or ISM radio wave radiated devices.

## Product Power State Table

The product, in accordance with the Ecodesign Requirements for Energy Related Products Directive 2009/125/EC and the Ecodesign for Energy-Related Products and Energy Information (Amendment) (EU Exit) Regulations 2020, is in compliance with the following norm(s) or document(s): Regulation (EC) No. 1275/2008, as amended by Regulation (EU) No. 801/2013.

Required Power State Information	Power Modes	
	Standby	Networked Standby
Power consumption in specified power mode, at 230V/50Hz input	< 0.5 W	Wi-Fi®, <i>Bluetooth</i> ® < 2.0 W
Time after which equipment is automatically switched into mode	< 2.5 hours	≤ 20 minutes
Power consumption in networked standby if all wired network ports are connected and all wireless network ports are activated, at 230V/50Hz input	N/A	< 2.0 W
Network port deactivation/activation procedures. Deactivating all networks will enable standby mode.	<p><b>Wi-Fi</b>®: Deactivate by pressing and holding the Mute button and <i>Bluetooth</i>® button on the remote until the light bar on the soundbar pulses white twice then fades to black. Repeat to reactivate.</p> <p><b>Bluetooth</b>®: Deactivate by clearing the pairing list by pressing and holding the <i>Bluetooth</i>® button on the remote for 10 seconds. Activate by pairing with a <i>Bluetooth</i>® source.</p>	



**Please dispose of used batteries properly, following local regulations.**  
Do not incinerate.

廢電池回收

### China Restriction of Hazardous Substances Table

Names and Contents of Toxic or Hazardous Substances or Elements						
Part Name	Toxic or Hazardous Substances and Elements					
	Lead (Pb)	Mercury (Hg)	Cadmium (Cd)	Hexavalent (CR(VI))	Polybrominated Biphenyl (PBB)	Polybrominated diphenylether (PBDE)
PCBs	X	0	0	0	0	0
Metal Parts	X	0	0	0	0	0
Plastic Parts	0	0	0	0	0	0
Speakers	X	0	0	0	0	0
Cables	X	0	0	0	0	0
This table is prepared in accordance with the provisions of SJ/T 11364. O: Indicates that this toxic or hazardous substance contained in all of the homogeneous materials for this part is below the limit requirement of GB/T 26572. X: Indicates that this toxic or hazardous substance contained in at least one of the homogeneous materials used for this part is above the limit requirement of GB/T 26572.						

### Taiwan Restriction of Hazardous Substances Table

Equipment name: Powered Speaker, Type designation: 432552						
Unit	Restricted substances and its chemical symbols					
	Lead (Pb)	Mercury (Hg)	Cadmium (Cd)	Hexavalent chromium (Cr+6)	Polybrominated biphenyls (PBB)	Polybrominated diphenyl ethers (PBDE)
PCBs	-	o	o	o	o	o
Metal Parts	-	o	o	o	o	o
Plastic Parts	o	o	o	o	o	o
Speakers	-	o	o	o	o	o
Cables	-	o	o	o	o	o
<b>Note 1:</b> "o" indicates that the percentage content of the restricted substance does not exceed the percentage of reference value of presence.						
<b>Note 2:</b> The "-" indicates that the restricted substance corresponds to the exemption.						

**Date of Manufacture:** The eighth digit in the serial number indicates the year of manufacture; "0" is 2010 or 2020.

**China Importer:** Bose Electronics (Shanghai) Company Limited, Level 6, Tower D, No. 2337 Gudai Rd. Minhang District, Shanghai 201100

**EU Importer:** Bose Products B.V., Gorslaan 60, 1441 RG Purmerend, The Netherlands

**Taiwan Importer:** Bose Taiwan Branch, 9F-A1, No. 10, Section 3, Minsheng East Road, Taipei City 104, Taiwan  
Phone Number: +886-2-2514 7676

**Mexico Importer:** Bose de México, S. de R.L. de C.V., Paseo de las Palmas 405-204, Lomas de Chapultepec, 11000 México, D.F. Phone Number: +5255 (5202) 3545

**UK Importer:** Bose Limited, Bose House, Quayside Chatham Maritime, Chatham, Kent, ME4 4QZ, United Kingdom

**Input Rating:** 100-240V ~ 50/60Hz, 100W

The CMIIT ID is located on the product label on the back of the soundbar.

**California:** Contains lithium ion battery with Perchlorate Material - special handling may apply.  
See [www.dtsc.ca.gov/hazardouswaste/perchlorate](http://www.dtsc.ca.gov/hazardouswaste/perchlorate)

**Please complete and retain for your records**

The serial and model numbers are located on the back of the soundbar.

Serial number: \_\_\_\_\_

Model number: \_\_\_\_\_

Please keep your receipt with your owner's guide. Now is a good time to register your Bose product. You can easily do this by going to [global.Bose.com/register](https://global.Bose.com/register)

**Security Information**

This product is capable of receiving automatic security updates from Bose. To receive automatic security updates, you must complete the product setup process in the Bose Music app and connect the product to the Internet. **If you do not complete the setup process, you will be responsible for installing security updates that Bose makes available.**

Amazon, Alexa, Amazon Music, and all related logos are trademarks of Amazon.com, Inc. or its affiliates.

Apple, the Apple logo, AirPlay, and Apple Music are trademarks of Apple Inc., registered in the U.S. and other countries. App Store is a service mark of Apple Inc.

Use of the Works with Apple badge means that an accessory has been designed to work specifically with the technology identified in the badge and has been certified by the developer to meet Apple performance standards.

The *Bluetooth*<sup>®</sup> word mark and logos are registered trademarks owned by Bluetooth SIG, Inc. and any use of such marks by Bose Corporation is under license.

 Dolby, Dolby Audio, and the double-D symbol are trademarks of Dolby Laboratories Licensing Corporation. Manufactured under license from Dolby Laboratories. Confidential unpublished works. Copyright 1992–2019 Dolby Laboratories. All rights reserved.

Google and Google Play are trademarks of Google LLC.

 The terms HDMI, HDMI High-Definition Multimedia Interface, and the HDMI logo are trademarks or registered trademarks of HDMI Licensing Administrator, Inc.

This product contains the iHeartRadio service. iHeartRadio is a registered trademark of iHeartMedia, Inc.

This product is protected by certain intellectual property rights of Microsoft. Use or distribution of such technology outside of this product is prohibited without a license from Microsoft.

Pandora is a trademark or registered trademark of Pandora Media, Inc. used with permission.

QuickSet is a registered trademark of Universal Electronics Inc. in the United States and Internationally.

This product incorporates Spotify software which is subject to third-party licenses found here: [www.spotify.com/connect/third-party-licenses](https://www.spotify.com/connect/third-party-licenses)

Spotify is a registered trademark of Spotify AB.

Wi-Fi is a registered trademark of Wi-Fi Alliance<sup>®</sup>.

Acoustimass, Bose, Bose Bass Module, Bose Music, Bose Noise Cancelling Headphones, Bose Smart Soundbar, Bose Soundbar Wall Bracket, Bose Surround Speakers, SimpleSync, SoundLink, SoundLink Revolve, Virtually Invisible, and Voice4Video are trademarks of Bose Corporation.

Bose Corporation Headquarters: 1-877-230-5639

©2022 Bose Corporation. No part of this work may be reproduced, modified, distributed, or otherwise used without prior written permission.

To view the license disclosures that apply to the third-party software packages included as components of your Bose Smart Soundbar 300 product:

1. On the remote, press and hold the Play/Pause button >|| and Volume up button + for 5 seconds.
2. Connect a micro-USB cable to the SERVICE port on the back of the soundbar.
3. Connect the other end of the cable to a computer.
4. On the computer, enter **<http://203.0.113.1/opensource>** in a browser window to display the EULA and license disclosure.



**WHAT'S IN THE BOX**

Contents ..... 12

**SOUNDBAR PLACEMENT**

Recommendations..... 13

Wall mount the soundbar ..... 14

Adjust audio for wall mounting..... 14

**POWER**

Connect the soundbar to power..... 15

Network standby..... 15

**BOSE MUSIC APP SETUP**

Download the Bose Music app..... 16

**EXISTING BOSE MUSIC APP USERS**

Add the soundbar to an existing account..... 17

Connect to a different Wi-Fi® network..... 17

**SOUNDBAR CONTROLS**

Remote functions..... 18

Power on/off..... 19

Sources ..... 20

Media playback and volume..... 21

Voice assistant controls..... 22

Adjust the bass ..... 22

Dialogue mode..... 22

Program a third-party remote ..... 23

**VOICE ASSISTANT**

Voice assistant options..... 24

Set up your voice assistant ..... 24

Access Google Assistant..... 25

    Use your voice ..... 25

    Use the soundbar controls..... 26

Play music with Google Assistant ..... 27

    Choose a default audio service..... 27

Access Amazon Alexa..... 28

    Use your voice ..... 28

    Use the soundbar controls..... 29

Control audio with Voice4Video™ ..... 30

    Set up Voice4Video™ ..... 30

**BLUETOOTH® CONNECTIONS**

Connect a mobile device ..... 32

Disconnect a mobile device..... 33

Reconnect a mobile device..... 33

Connect an additional mobile device ..... 34

Clear the soundbar device list ..... 34

**STREAM AUDIO WITH AIRPLAY**

Stream audio from the Control Center..... 35

Stream audio from an app ..... 35

**SOUNDBAR STATUS**

Wi-Fi status ..... 36

*Bluetooth* status ..... 36

Voice assistant status..... 37

    Microphone off light ..... 37

Media playback and volume status ..... 38

Update and error status ..... 38

**ADVANCED FEATURES**

Disable/enable Wi-Fi capability ..... 39

**CONNECT BOSE PRODUCTS**

Compatible accessories ..... 40

Connect a Bose SoundLink *Bluetooth* speaker or  
Bose Noise Cancelling Headphones 700 ..... 40

    Benefits..... 40

    Compatible products ..... 40

    Connect using the Bose Music app ..... 41

Reconnect a Bose SoundLink *Bluetooth* speaker or  
Bose Noise Cancelling Headphones 700 ..... 41

**CARE AND MAINTENANCE**

Update the soundbar ..... 42

Replace the remote battery..... 42

Clean the soundbar..... 44

Replacement parts and accessories..... 44

Limited warranty ..... 44

**TROUBLESHOOTING**

Try these solutions first ..... 45

Other solutions ..... 45

Reset the soundbar..... 53

**APPENDIX: SETUP REFERENCE**

Connection options..... 54

Connect the soundbar to your TV ..... 55

    Option 1: HDMI ARC (not provided)..... 55

    Option 2: Optical..... 56

Check for sound ..... 57

## CONTENTS

Confirm that the following parts are included:



Bose Smart Soundbar 300



Remote (battery included)

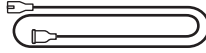

Power cord\*

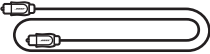

Optical cable

\* May ship with multiple power cords. Use the power cord for your region.

**NOTE:** If any part of the product is damaged, don't use it. Contact your authorized Bose dealer or Bose customer service.

Visit: [worldwide.Bose.com/Support/SB300](http://worldwide.Bose.com/Support/SB300)

## RECOMMENDATIONS

- Place the soundbar outside of and away from metal cabinets, other audio/video components, and direct heat sources.
- Place the soundbar directly below (preferred) or above your TV with the grille facing into the room.
- Place the soundbar on its rubber feet on a stable and level surface. For proper support, both feet must be resting on the surface. Vibration can cause the soundbar to move, particularly on smooth surfaces like marble, glass, or highly polished wood.
- If placing the soundbar on a shelf or TV stand, position the front of the soundbar as close as possible to the front edge of the shelf or stand for best sound quality.
- Keep the back side of the soundbar at least 0.4 in (1 cm) from any other surface. Blocking the port(s) on this side affects sound quality.
- Make sure there is an AC (mains) outlet nearby.
- To avoid wireless interference, keep other wireless equipment at least 1 – 3 ft (0.3 – 0.9 m) away from the soundbar.
- For best sound quality, don't place the soundbar in an enclosed cabinet or diagonally in a corner.
- Don't place any objects on top of the soundbar.

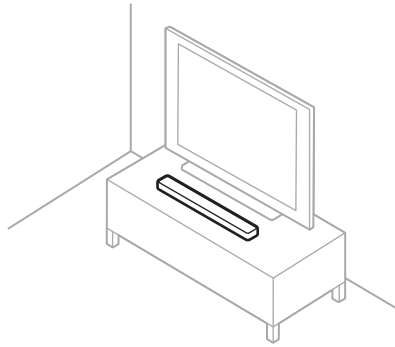

**CAUTION:** Do NOT place the soundbar on its front, back, or top when in use.

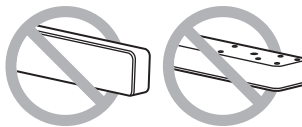

## WALL MOUNT THE SOUNDBAR

You can mount the soundbar on a wall. To purchase the Bose Soundbar Wall Bracket, contact your authorized Bose dealer.

Visit: [worldwide.Bose.com/Support/SB300](https://worldwide.Bose.com/Support/SB300)

**CAUTION:** Do NOT use any other hardware to mount the soundbar.

### Adjust audio for wall mounting

After you mount the soundbar, you must adjust audio for best sound quality.

On the remote, press and hold the Mute button  for 5 seconds until you hear a tone and the light bar pulses white twice.

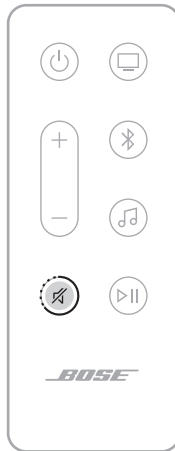

**NOTE:** If you remove the soundbar from the wall, repeat to return the soundbar to default audio settings.

**TIP:** You can also adjust audio for wall mounting using the Bose Music app.

## CONNECT THE SOUNDBAR TO POWER

1. Connect the power cord to the **POWER** port on the back of the soundbar.
2. Plug the other end of the power cord into an AC (mains) outlet.

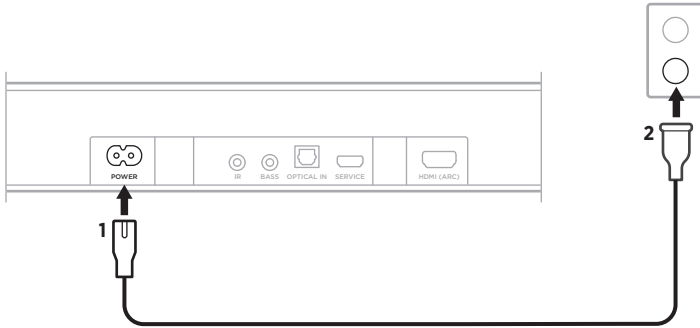

The soundbar powers on, and the light bar glows solid amber.

## NETWORK STANDBY

The soundbar transitions to network standby when audio has stopped and you have not pressed any buttons for 20 minutes. To wake the soundbar from network standby:

- On the remote, press the Power button (⏻), a source button (see page 20), or the Play/Pause button (⏮) (see page 18).
- Play or resume audio using your mobile device or using the Bose Music app.
- Talk to Google Assistant or Amazon Alexa.

### NOTES:

- To access your voice assistant in network standby, make sure the soundbar has been set up using the Bose Music app (see page 16) and the microphone is on (see page 37).
- You can disable the standby timer using the Bose Music app. You can access this option from the Settings menu.

The Bose Music app lets you set up and control the soundbar from any mobile device, such as a smartphone or tablet.

Using the app, you can stream music, set and change presets, add music services, explore internet radio stations, configure Google Assistant or Amazon Alexa, choose your voice prompt language, manage soundbar settings, and get new features.

**NOTE:** If you have already created a Bose Music account for another Bose product, add the soundbar to your existing account (see page 17).

## DOWNLOAD THE BOSE MUSIC APP

1. On your mobile device, download the Bose Music app.

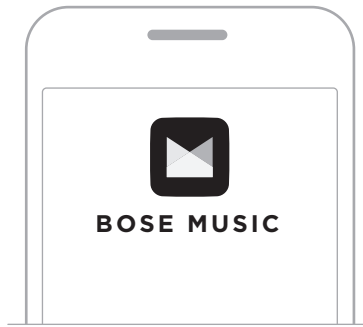

2. Follow the app instructions.





## ADD THE SOUNDBAR TO AN EXISTING ACCOUNT

In the Bose Music app, go to the My Products screen and add your Bose Smart Soundbar 300.

## CONNECT TO A DIFFERENT WI-FI NETWORK

Connect to a different network if your network name or password has changed or if you want to change or add another network.

1. On the remote, press and hold the Mute button  and Bose Music app button  until the light bar glows amber.

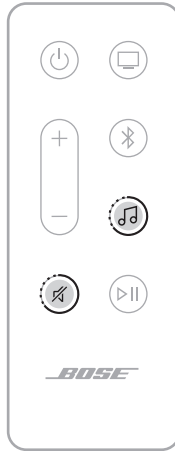

2. On your mobile device, open your Wi-Fi settings.
3. Select **Bose Smart Soundbar 300**.
4. Open the Bose Music app and follow the app instructions.

**NOTE:** If the app doesn't prompt you for setup, go to the My Products screen and add your soundbar.

The soundbar controls are located on the top of the soundbar and on the remote.

**TIP:** You can also control the soundbar using the Bose Music app.

## REMOTE FUNCTIONS

Use the remote to control the soundbar, *Bluetooth* connections, and Bose Music app.

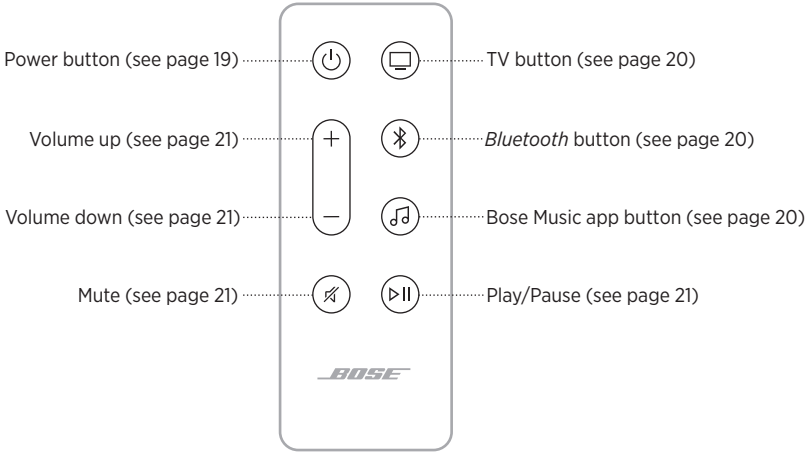

## Power on/off

On the remote, press the Power button  to power the soundbar on/off.

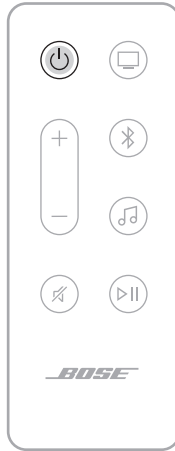

When powered on, the soundbar defaults to the last active source.

### NOTES:

- When you plug the soundbar into an AC (mains) outlet, the soundbar automatically powers on.
- The first time the soundbar is powered on, the soundbar defaults to the TV  source.
- You can still access your voice assistant when the soundbar is powered off.

**TIP:** You can also use Voice4Video™ to power the soundbar on/off (see page 30).

### Auto-wake (optical connection only)



You can set the soundbar to power on whenever a sound signal is received.

To toggle between auto-wake and default power settings, on the remote, press and hold  for 5 seconds until you hear a tone and the light bar pulses white twice.

**TIP:** You can also enable/disable auto-wake using the Bose Music app. You can access this option from the Settings menu.

## Sources

You can control your TV, *Bluetooth* connections, and Bose Music app using your remote.

To select a source, press the appropriate button (TV , *Bluetooth* , or Bose Music app ) on the remote.

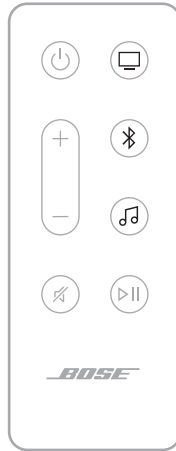

### TIPS:

- You can also use Voice4Video™ to select your *Bluetooth* source (see page 30).
- You can also use the Bose Music app to select a source.

## Media playback and volume

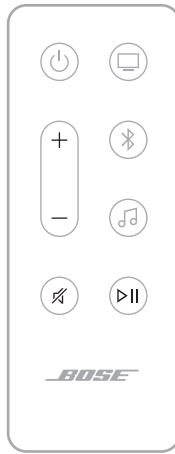

FUNCTION	WHAT TO DO
<b>Play/Pause</b>	<p>Press ▷  .</p> <p><b>NOTES:</b></p> <ul style="list-style-type: none"> <li>When audio is paused, two lights in the center of the light bar glow solid white until audio resumes.</li> <li>You can only play/pause audio when the Bose Music app or <i>Bluetooth</i> is your source.</li> </ul>
<b>Skip forward</b>	Double-press ▷  .
<b>Skip backward</b>	Triple-press ▷  .
<b>Volume up</b>	<p>Press +.</p> <p><b>NOTE:</b> To quickly increase the volume, press and hold +.</p>
<b>Volume down</b>	<p>Press —.</p> <p><b>NOTE:</b> To quickly decrease the volume, press and hold —.</p>
<b>Mute/Unmute</b>	<p>Press 🔇.</p> <p>When audio is muted, the left side of the light bar glows solid white until audio resumes.</p> <p><b>TIP:</b> You can also press + to unmute audio.</p>

**TIP:** You can also use Voice4Video™ to control media playback and volume for certain sources (see page 30).

## VOICE ASSISTANT CONTROLS

You can use the Action button  and Microphone off button  to control Google Assistant (see page 26) or Amazon Alexa (see page 29).

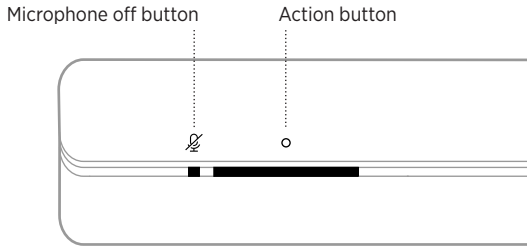

## ADJUST THE BASS

To adjust the bass, use the Bose Music app.

## DIALOGUE MODE

Dialogue mode improves the clarity of dialogue and vocals in movies, TV programs, and podcasts by adjusting the audio balance of the soundbar.

To enable Dialogue mode, use the Bose Music app.

**NOTE:** When you enable Dialogue mode, it stays enabled for your current source even if you switch to another source or power off the soundbar.

## **PROGRAM A THIRD-PARTY REMOTE**

You can program a third-party remote, such as your cable/satellite box remote, to control the soundbar. Refer to your third-party remote owner's guide or website for instructions.

Once programmed, the third-party remote controls basic soundbar functions such as power on/off and volume.



**NOTE:** Not all third-party remotes are compatible with the soundbar. The remote must support IR (infrared) signals in order to control the soundbar.

## VOICE ASSISTANT OPTIONS

You can set the soundbar to quickly and easily access Google Assistant or Amazon Alexa.

### NOTE:

- You can't set the soundbar to access Google Assistant and Amazon Alexa at the same time.
- Google Assistant and Amazon Alexa aren't available in certain languages and countries.

PROGRAMMING OPTIONS	HOW TO USE
<b>Google Assistant</b>	Use your voice and/or the Action button  (see page 25).
<b>Amazon Alexa</b>	Use your voice and/or the Action button  (see page 28).

## SET UP YOUR VOICE ASSISTANT

Before you begin, make sure your mobile device and the soundbar are connected to the same Wi-Fi network.

To set up your voice assistant, use the Bose Music app. You can access this option from the Settings menu.

### NOTES:

- When setting up your voice assistant, make sure you use the same audio service account that you used in the Bose Music app.
- If you have multiple Bose Music products in your household, for a seamless voice assistant experience, Bose recommends one person use their Bose Music account and voice assistant account to set up the voice assistant for all Bose Music products.



## ACCESS GOOGLE ASSISTANT

Your soundbar with Google Assistant. You can easily enjoy music at home; you can play your favorite music, control volume, and find information about the song that you are listening to, hands-free. You can also plan your day, set alarms, and control smart devices around your home – just by using your voice. Just start by saying “Hey Google” or tap the Action button  to start a conversation with Google Assistant.

For more information about what Google Assistant can do, visit:  
<https://support.google.com/assistant>

### NOTES:

- Google Assistant isn't available in certain languages and countries.
- For more information about playing music with Google Assistant, see page 27.

## Use your voice





Start with “Hey Google,” then say:

THINGS TO TRY	EXAMPLES OF WHAT TO SAY
Enjoy entertainment	Play some music
Plan your day	Tell me about my day
Manage tasks	Wake me up at 7 a.m. tomorrow
Control your home	Dim the lights
Get answers	What's the weather this weekend?

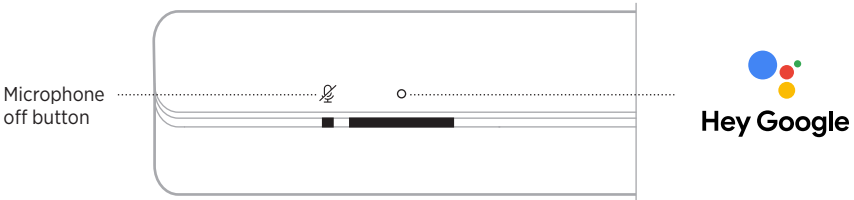
## Use the soundbar controls

You can use the Action button  and Microphone off button  to control Google Assistant. They are located on the top of the soundbar.



THINGS TO TRY	WHAT TO DO
<b>Talk to Google Assistant</b>	Tap  then say your request. For a list of things to try, visit: <a href="https://support.google.com/assistant">https://support.google.com/assistant</a>
<b>Stop alarms and timers</b>	Tap  .
<b>Stop Google Assistant</b>	Tap  .
<b>Turn the microphone on/off</b>	Tap  . <b>NOTE:</b> When the microphone is off, the Microphone off light glows solid red, and you can't access Google Assistant.

## PLAY MUSIC WITH GOOGLE ASSISTANT

You can ask Google Assistant to play music from your default audio service or from a specific audio service.

Start with “Hey Google,” then say:

THINGS TO TRY	EXAMPLES OF WHAT TO SAY
<b>Play music</b>	<p>Play some music.</p> <p><b>NOTE:</b> Google Assistant uses your default audio service. To change the default audio service, use the Google Assistant app.</p>
<b>Control your speaker</b>	<p>Turn up the volume.</p>
<b>Play from a specific audio service</b>	<p>Play NPR on TuneIn.</p> <p><b>NOTE:</b> Google Assistant doesn't support all audio services.</p>
<b>Play on a specific speaker</b>	<p>Play some jazz on the living room speakers.</p> <p><b>NOTE:</b> Make sure you say the speaker name you assigned in the Bose Music app. If multiple speakers have the same name, use the name assigned in the Google Assistant app or change the name in the Bose Music app.</p>

### Choose a default audio service

During initial setup for Google Assistant, the Google Assistant app prompts you to select a default audio service. When using Google Assistant with Bose products, only Pandora and Spotify are supported default services. Although other audio services are listed as available during setup, they are not supported.

For the best experience, choose Pandora or Spotify as your default audio service. If you choose an unsupported audio service, you hear an error message when requesting to play music.

## ACCESS AMAZON ALEXA

Alexa is the intelligent cloud-based voice service that you can talk to on your soundbar. All you have to do is ask Alexa to play music, hear the news, set a timer, control your smart home, and more. Alexa is also designed to protect your privacy – you can view and delete your voice requests at any time in the Alexa app.

For more information about what Alexa can do, visit:

<https://www.amazon.com/usealexa>



**NOTE:** Alexa isn't available in all languages and countries.

### Use your voice

Start with “Alexa,” then say:

THINGS TO TRY	EXAMPLES OF WHAT TO SAY
<b>Talk to Alexa</b>	Help me get started.
<b>Play audio</b>	Play rock music. <b>NOTE:</b> Amazon Music is set as the default music service. To change the default music service, use the Alexa app.
<b>Pause audio</b>	Pause.
<b>Control volume</b>	Volume up.
<b>Skip to the next song</b>	Skip.
<b>Play from a specific audio service</b>	Play NPR on Tunein. <b>NOTE:</b> Amazon Alexa doesn't support all audio services.
<b>Play on a specific speaker</b>	Play jazz in the “Kitchen.” <b>NOTE:</b> Make sure you say the speaker name you assigned in the Bose Music app. If multiple speakers have the same name, use the name assigned in the Alexa app or change the name in the Bose Music app.
<b>Set a timer</b>	Set a timer for five minutes.
<b>Discover more skills</b>	What are your popular skills?
<b>Stop Alexa</b>	Stop.



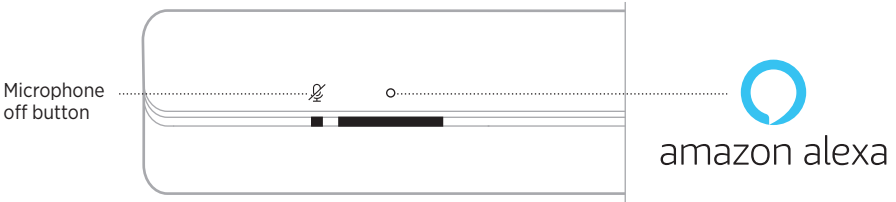

## Use the soundbar controls

The Action button  and Microphone off button  are used to control Alexa. They are located on the top of the soundbar.



### THINGS TO TRY

### WHAT TO DO

<p><b>Talk to Alexa</b></p>	<p>Tap  then say your request. For a list of things to try, visit: <a href="https://www.amazon.com/usealexa">https://www.amazon.com/usealexa</a></p>
<p><b>Stop alarms and timers</b></p>	<p>Tap .</p>
<p><b>Stop Alexa</b></p>	<p>Tap .</p>
<p><b>Turn the microphone on/off</b></p>	<p>Tap .</p> <p><b>NOTE:</b> When the microphone is off, the Microphone off light glows solid red, and you can't access Alexa.</p>

## CONTROL AUDIO WITH VOICE4VIDEO™

Bose Voice4Video™ technology expands your Amazon Alexa voice capabilities like no other soundbar can. In addition to controlling your smart soundbar, you can control your TV and cable or satellite box with just your voice. With one simple ask of Alexa, you can turn on your TV and smart soundbar, tune to a station by network name or channel number, and start watching your favorite shows instantly. Say goodbye to missing remotes and remote tutorials, because Bose Voice4Video™ will make everyone feel like experts — even the babysitter or your tech-troubled in-laws.

### Set up Voice4Video™

To set up Voice4Video™, use the Bose Music app.

**NOTE:** Before setting up Voice4Video™, you must set up Alexa in the Bose Music app (see page 24).

## Use your voice

Start with “Alexa,” then say:

THINGS TO TRY	EXAMPLES OF WHAT TO SAY
<b>Power on TV</b>	Turn on TV.
<b>Power off TV</b>	Turn off TV.
<b>Play video</b>	Play.
<b>Pause video</b>	Pause.
<b>Resume video</b>	Resume.
<b>Skip video forward</b>	Next.
<b>Skip video backward</b>	Previous.
<b>Switch input to <i>Bluetooth</i> audio</b>	Switch to <i>Bluetooth</i> .
<b>Watch a specific network*</b>	Watch NFL Network.
<b>Watch a specific channel number*</b>	Watch channel 802.
<b>Skip to the next channel*</b>	Next channel.
<b>Skip backward to the previous channel*</b>	Previous channel.

\*Only available for cable or satellite boxes.

## CONNECT A MOBILE DEVICE

1. On the remote, press the *Bluetooth* button .



The light bar pulses blue.

2. On your mobile device, turn on the *Bluetooth* feature.

**NOTE:** The *Bluetooth* menu is usually found in the Settings menu.



3. Select your soundbar from the device list.

**NOTE:** Look for the name you entered for your soundbar in the Bose Music app. If you didn't name your soundbar, the default name appears.

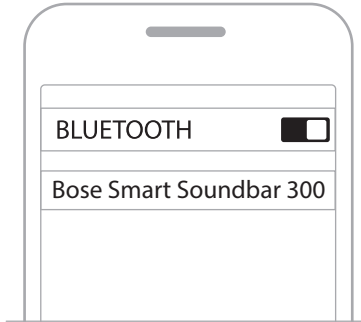

Once connected, you hear a tone, and the light bar glows solid white then fades to black. The soundbar's name appears in the mobile device list.

## DISCONNECT A MOBILE DEVICE

To disconnect your mobile device, use the Bose Music app.

**TIP:** You can also use *Bluetooth* settings on your mobile device. Disabling the *Bluetooth* feature disconnects all other devices.

## RECONNECT A MOBILE DEVICE

On the remote, press the *Bluetooth* button .

The soundbar tries to connect with the most recently-connected device.

### NOTES:

- Make sure the *Bluetooth* feature is enabled on your mobile device.
- The device must be within 30 ft (9 m) and powered on.

## CONNECT AN ADDITIONAL MOBILE DEVICE

You can store up to eight devices in the soundbar device list.

**NOTE:** You can play audio from only one device at a time.

1. On the remote, press and hold the *Bluetooth* button  until the light bar pulses blue.

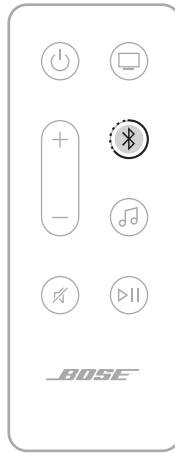

2. On your mobile device, select your soundbar from the device list.

**NOTE:** Make sure the *Bluetooth* feature is enabled on your mobile device.

## CLEAR THE SOUNDBAR DEVICE LIST

1. On the remote, press and hold  for 10 seconds until the light bar pulses white twice then fades to black.

The light bar pulses blue.

2. Delete the soundbar from the *Bluetooth* list on your device.

All devices are cleared, and the soundbar is ready to connect (see page 32).

The soundbar is capable of playing AirPlay 2 audio, which allows you to quickly stream audio from your Apple device to the soundbar or multiple speakers.

**NOTES:**

- To use AirPlay 2, you need an Apple device running iOS 11.4 or later.
- Your Apple device and soundbar must be connected to the same Wi-Fi network.
- For more information about AirPlay, visit: <https://www.apple.com/airplay>

## **STREAM AUDIO FROM THE CONTROL CENTER**

1. On your Apple device, open the Control Center.
2. Tap and hold the audio card in the top-right corner of the screen, then tap the AirPlay icon .
3. Select your soundbar.

## **STREAM AUDIO FROM AN APP**

1. Open a music app (like Apple Music), and select a track to play.
2. Tap .
3. Select your soundbar.

The LED light bar located on the front of the soundbar shows the soundbar status.

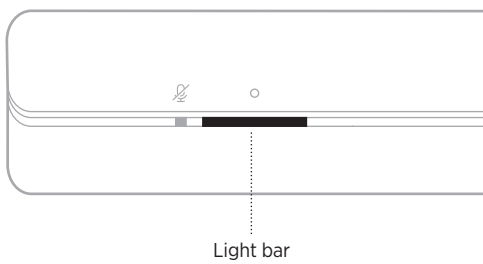

**NOTE:** The light bar displays one status at a time of the selected source.

## WI-FI STATUS

Shows the Wi-Fi connection status of the soundbar.

LIGHT BAR ACTIVITY		SYSTEM STATE
Pulsing white		Connecting to Wi-Fi
Solid white then fades to black		Connected to Wi-Fi





## BLUETOOTH STATUS

Shows the *Bluetooth* connection status of mobile devices.

LIGHT BAR ACTIVITY		SYSTEM STATE
Pulsing blue		Ready to connect to mobile device
Pulsing white		Connecting to mobile device
Solid white then fades to black		Connected to mobile device
White light pulses twice then fades to black		Clearing device list

## VOICE ASSISTANT STATUS

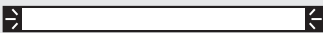
Shows the status of your voice assistant.

LIGHT BAR ACTIVITY		SYSTEM STATE
Off		Voice assistant is idle
White light slides to the center then glows solid		Voice assistant is listening
White light slides to the sides		Voice assistant is thinking
Pulsing white (full)		Voice assistant is speaking
Pulsing yellow		Notification from voice assistant

## Microphone off light

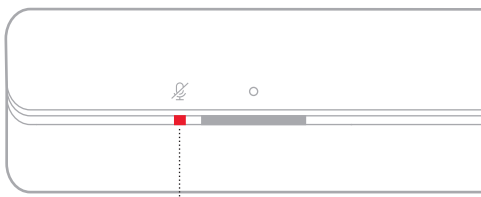





Microphone off light

LIGHT ACTIVITY	SYSTEM STATE
Solid red	The microphone is off







## MEDIA PLAYBACK AND VOLUME STATUS

Shows the soundbar status when controlling media playback and volume.



LIGHT BAR ACTIVITY		SYSTEM STATE
Two center lights glow solid white		Pause
Right end of the light bar pulses white		Volume up
Left end of the light bar pulses white		Volume down
Left end of the light bar glows solid white		Mute

## UPDATE AND ERROR STATUS

Shows the status of software updates and error alerts.

LIGHT BAR ACTIVITY		SYSTEM STATE
Solid amber		Wi-Fi setup in progress
White light slides from right to left		Downloading update
White light slides from left to right		Updating soundbar
Pulses amber 4 times		Source error - refer to the Bose Music app
Pulses red 4 times		Request is temporarily unavailable - try again later
Solid red		Error - contact Bose customer service

## DISABLE/ENABLE WI-FI CAPABILITY

On the remote, press and hold the Mute button  and *Bluetooth* button  until the light bar pulses white twice then fades to black.



## COMPATIBLE ACCESSORIES

You can connect any of these accessories to the soundbar. For more information, refer to your accessory owner's guide.

- **Bose Bass Module 700:** [worldwide.Bose.com/Support/BASS700](http://worldwide.Bose.com/Support/BASS700)
- **Bose Bass Module 500:** [worldwide.Bose.com/Support/BASS500](http://worldwide.Bose.com/Support/BASS500)
- **Acoustimass 300 bass module:** [global.Bose.com/Support/AM300](http://global.Bose.com/Support/AM300)
- **Bose Surround Speakers 700:** [worldwide.Bose.com/Support/WSS700](http://worldwide.Bose.com/Support/WSS700)
- **Bose Surround Speakers:** [worldwide.Bose.com/Support/WSS](http://worldwide.Bose.com/Support/WSS)
- **Virtually Invisible 300 wireless surround speakers:**  
[global.Bose.com/Support/VI300](http://global.Bose.com/Support/VI300)

## CONNECT A BOSE SOUNDLINK *BLUETOOTH* SPEAKER OR BOSE NOISE CANCELLING HEADPHONES 700

With Bose SimpleSync™ technology, you can connect certain Bose SoundLink *Bluetooth* speakers or Bose Noise Cancelling Headphones 700 to the soundbar for a new way to hear your music and movies.

### Benefits

- **A personal TV listening experience:** Listen to TV without disturbing others by connecting your Bose Noise Cancelling Headphones 700 to the soundbar. Use independent volume controls on each product to lower or mute the soundbar while keeping your headphones as loud as you like.
- **Another room of audio:** Listen to the same song in two different rooms at the same time by connecting your Bose SoundLink *Bluetooth* speaker to the soundbar.

**NOTE:** SimpleSync™ technology has a *Bluetooth* range of 30 ft (9 m). Walls and construction materials can affect reception.

### Compatible products

You can connect most Bose SoundLink *Bluetooth* speakers to the soundbar, as well as Bose Noise Cancelling Headphones 700.

Popular compatible products include:

- Bose SoundLink Revolve+ *Bluetooth* speaker
- Bose SoundLink Mini *Bluetooth* speaker
- Bose SoundLink Color *Bluetooth* speaker
- Bose Noise Cancelling Headphones 700

New products are added periodically. For a complete list and more information, visit: [worldwide.Bose.com/Support/Groups](http://worldwide.Bose.com/Support/Groups)



## Connect using the Bose Music app

To connect your Bose SoundLink *Bluetooth* speaker or Bose Noise Cancelling Headphones 700 to the soundbar, use the Bose Music app. For more information, visit: [worldwide.bose.com/Support/Groups](https://worldwide.bose.com/Support/Groups)

### NOTES:

- Make sure that the product you're connecting to is powered on, within 30 ft (9 m) of the soundbar, and ready to connect to another device. For more information, refer to your product owner's guide.
- You can connect only one product at a time to the soundbar.

## RECONNECT A BOSE SOUNDLINK *BLUETOOTH* SPEAKER OR BOSE NOISE CANCELLING HEADPHONES 700

Power on your Bose SoundLink *Bluetooth* speaker or Bose Noise Cancelling Headphones 700.

Your speaker or headphones try to connect to the most recently-connected *Bluetooth* device, including the soundbar.

### NOTES:

- The soundbar must be within range (30 ft or 9 m) and powered on.
- If your speaker doesn't connect, see "Soundbar doesn't reconnect to a previously-connected Bose SoundLink *Bluetooth* speaker" on page 51.
- If your headphones don't connect, see "Soundbar doesn't reconnect to previously-connected Bose Noise Cancelling Headphones 700" on page 52.

## UPDATE THE SOUNDBAR

The soundbar updates automatically when connected to the Bose Music app and your Wi-Fi network.

## REPLACE THE REMOTE BATTERY

1. Using a coin, turn the battery compartment cover left (counter-clockwise) and remove the cover.

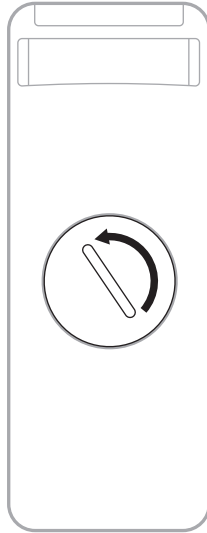

2. Insert the new battery flat side up, with the + symbol facing up.

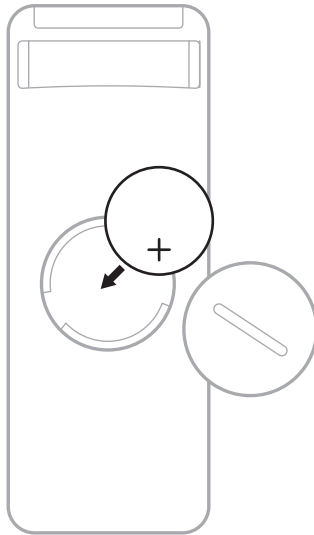

**NOTE:** Use only an agency approved (e.g., UL) CR2032 or DL2032 3-volt lithium battery.

3. Reset the cover and turn it right (clockwise) to lock in place.

## **CLEAN THE SOUNDBAR**

Wipe the outside surfaces of the soundbar with a soft, dry cloth.

### **CAUTIONS:**

- Do NOT allow liquids to spill onto the soundbar or into any openings.
- Do NOT blow air into the system.
- Do NOT use a vacuum to clean the system.
- Do NOT use any sprays near the system.
- Do NOT use any solvents, chemicals, or cleaning solutions containing alcohol, ammonia, or abrasives.
- Do NOT allow objects to drop into any openings.

## **REPLACEMENT PARTS AND ACCESSORIES**

Replacement parts and accessories can be ordered through Bose customer service.

Visit: [worldwide.Bose.com/Support/SB300](https://worldwide.Bose.com/Support/SB300)

## **LIMITED WARRANTY**

The soundbar is covered by a limited warranty. Visit our website at [global.Bose.com/warranty](https://global.Bose.com/warranty) for details of the limited warranty.

To register your product, visit [global.Bose.com/register](https://global.Bose.com/register) for instructions. Failure to register will not affect your limited warranty rights.

## TRY THESE SOLUTIONS FIRST



If you experience problems with the soundbar:

- Make sure the soundbar is connected to a live AC (mains) outlet.
- Secure all cables.
- Check the state of the soundbar (see page 35).
- Move the soundbar at least 1 – 3 ft (0.3 – 0.9 m) away from possible interference (wireless routers, cordless phones, televisions, microwaves, etc.).
- Move the soundbar within the recommended range of your wireless router or mobile device for proper operation.
- Place the soundbar according to the placement guidelines (see page 13).

## OTHER SOLUTIONS

If you could not resolve your issue, see the table below to identify symptoms and solutions to common problems. If you are unable to resolve your issue, contact Bose customer service.

Visit: [worldwide.Bose.com/contact](http://worldwide.Bose.com/contact)

SYMPTOM	SOLUTION
<b>No HDMI ARC or optical port on your TV</b>	Connect to your TV using an audio converter and separate audio cable, such as a coaxial, 3.5 mm, or analog audio cable (not provided). The type of converter and cable you need depends on the audio output ports available on your TV.
<b>Soundbar doesn't power on (light bar doesn't pulse when powered on)</b>	<p>Plug the power cord into a different AC (mains) outlet.</p> <p>Use the remote to power on the soundbar (see page 19).</p> <p>Unplug the power cords for the soundbar and optional bass module or surround speakers, wait 30 seconds, and plug them firmly into a live AC (mains) outlet.</p>
<b>Soundbar doesn't power off</b>	The soundbar may be in network standby mode. On the remote, press the Power button  to wake the soundbar. Press  again to power off the soundbar.
<b>Remote is inconsistent or doesn't work</b>	<p>Replace the battery (see page 42).</p> <p>Make sure the remote is within operating range (20 ft or 6 m) of the soundbar.</p> <p>Make sure there are no obstructions between the remote and the soundbar.</p>

SYMPTOM	SOLUTION
<p><b>Intermittent or no audio from soundbar</b></p>	<p>If the left side of the light bar is glowing solid white, the soundbar is muted. Press the Mute button  to unmute the soundbar.</p> <p>Make sure your mobile device isn't muted.</p> <p>Increase the volume on the soundbar (see page 21) or your mobile device.</p> <p>Switch to a different source (see page 20).</p> <p>Play audio from a different application or audio service.</p> <p>If the audio is from a Wi-Fi source, reset the router.</p> <p>Restart your mobile device.</p> <p>Make sure you're using a compatible <i>Bluetooth</i> mobile device.</p> <p>Make sure your HDMI cable is inserted into a port on your TV labeled <b>HDMI ARC (Audio Return Channel)</b>, not a standard HDMI port. If your TV doesn't have an HDMI ARC port, connect the soundbar using the optical cable (see page 56).</p> <p>If the soundbar is connected to your TV HDMI ARC port, make sure that <b>Consumer Electronics Control (CEC)</b> is enabled in your TV system menu. Your TV may refer to CEC by a different name. Refer to your TV owner's guide.</p> <p>Disconnect your HDMI cable from your TV HDMI ARC port and reconnect it.</p> <p>Insert the optical cable into a port on your TV labeled <b>Output</b> or <b>OUT</b>, not Input or IN.</p> <p>Unplug the power cords for the soundbar and optional bass module or surround speakers, wait 30 seconds, and plug them firmly into a live AC (mains) outlet.</p>
<p><b>Soundbar doesn't connect to bass module or surround speakers</b></p>	<p>Make sure the soundbar is up to date (see page 42).</p> <p>Refer to your bass module or surround speakers owner's guide for troubleshooting (see page 40).</p> <p>Make sure your bass module or surround speakers are compatible with the soundbar (see page 40).</p> <p>Unplug the power cords for the soundbar and optional bass module or surround speakers, wait 30 seconds, and firmly plug them into the AC (mains) outlet.</p>
<p><b>No audio from bass module or surround speakers</b></p>	<p>Make sure the soundbar is up to date (see page 42).</p> <p>Make sure your bass module or surround speakers are compatible with the soundbar (see page 40).</p> <p>Make sure the software is current in the Bose Music app.</p> <p>Adjust the bass level using the Bose Music app (see page 22).</p> <p>Switch to a different source (see page 20).</p>

SYMPTOM	SOLUTION
<p><b>Sound is coming from TV speaker</b></p>	<p>Make sure your HDMI cable is inserted into a port on your TV labeled <b>ARC (Audio Return Channel)</b>. If your TV doesn't have an HDMI ARC port, connect to the soundbar using the optical cable (see page 56).</p> <p>Turn off your TV speakers. Refer to your TV owner's guide.</p> <p>If the soundbar is connected to your TV HDMI ARC port, make sure that <b>Consumer Electronics Control (CEC)</b> is enabled in your TV system menu. Your TV may refer to CEC by a different name. Refer to your TV owner's guide.</p> <p>Disconnect your HDMI cable from your TV HDMI ARC port and reconnect it.</p> <p>Decrease your TV volume to its lowest setting.</p> <p>Connect to the soundbar using both your HDMI cable (see page 55) and the optical cable (see page 56).</p>
<p><b>Poor or distorted audio</b></p>	<p>Test different sources if available.</p> <p>Make sure that your TV can output surround sound audio. Refer to your TV owner's guide.</p> <p>If the audio is being played from another device, reduce the volume of that device.</p> <p>Adjust the bass level using the Bose Music app (see page 22).</p> <p>Power off your TV speakers. Refer to your TV owner's guide.</p> <p>If the soundbar is wall mounted, adjust the audio (see page 14).</p>
<p><b>Soundbar doesn't play audio from the correct source or selects the incorrect source after a delay</b></p>	<p>Set CEC to <b>Alternate On</b> using the Bose Music app.</p> <p>Disable CEC on your source. Refer to the source owner's guide.</p> <p>Connect to the soundbar using both your HDMI cable (see page 55) and the optical cable (see page 56).</p>

SYMPTOM	SOLUTION
<p><b>Soundbar doesn't connect to Wi-Fi network</b></p>	<p>Make sure the soundbar has been set up using the Bose Music app (see page 16).</p> <p>In the Bose Music app, select the correct network name and enter the network password (case-sensitive).</p> <p>Make sure the soundbar and your mobile device are connected to the same Wi-Fi network.</p> <p>If your network information has changed, see page 17.</p> <p>Enable Wi-Fi on the mobile device you are using for setup.</p> <p>Close other open applications on your mobile device.</p> <p>Restart your mobile device and router.</p> <p>If your router supports both 2.4GHz and 5GHz bands, make sure both the device (mobile or computer) and soundbar are connecting to the same band.</p> <p><b>NOTE:</b> Give each band a unique name to make sure you're connecting to the correct band.</p> <p>Reset the router.</p> <p>Unplug the power cords for the soundbar and optional bass module or surround speakers, wait 30 seconds, and firmly plug them into the AC (mains) outlet. Uninstall the Bose Music app on your mobile device, reinstall the app, and restart setup.</p>
<p><b>Soundbar doesn't connect to mobile device</b></p>	<p>On the remote, press and hold the <i>Bluetooth</i> button  to make sure the soundbar is ready to connect.</p> <p>On your mobile device, make sure Location Services are turned on.</p> <p>On your mobile device, turn the <i>Bluetooth</i> feature off and then on. Delete the soundbar from the <i>Bluetooth</i> list. Connect again (see page 34).</p> <p>Connect a different mobile device (see page 34).</p> <p>Make sure you're using a compatible <i>Bluetooth</i> mobile device.</p> <p>Delete the soundbar from your mobile device <i>Bluetooth</i> list. Connect again (see page 34).</p> <p>Clear the soundbar device list (see page 34). Connect again (see page 32).</p>



SYMPTOM	SOLUTION
<b>Soundbar doesn't stream audio using AirPlay</b>	<p>Make sure the soundbar is powered on and in range (see page 19).</p> <p>Make sure your Apple device and the soundbar are connected to the same Wi-Fi network.</p> <p>Update your Apple device.</p> <p>Make sure the soundbar is up to date (see page 42).</p> <p>If you can't find the AirPlay icon  in the music app you are streaming from, stream audio from the Control Center.</p> <p>For additional support, visit: <a href="https://www.apple.com/airplay">https://www.apple.com/airplay</a></p>
<b>Bose Music app doesn't work on mobile device</b>	<p>Make sure your mobile device is compatible with the Bose Music app and meets minimum system requirements. For more information, refer to the app store on your mobile device.</p> <p>Uninstall the Bose Music app on your mobile device then reinstall the app (see page 16).</p>
<b>Soundbar isn't visible to add to another Bose account</b>	<p>Make sure sharing is enabled on the soundbar using the Bose Music app.</p> <p>Make sure the soundbar and your mobile device are connected to the same Wi-Fi network.</p>

SYMPTOM	SOLUTION
<p><b>Your Google Assistant doesn't respond</b></p>	<p>Make sure the Microphone off light is not glowing red. To turn on the microphone, see page 26.</p> <p>Make sure Google Assistant has been set up using the Bose Music app (see page 24).</p> <p><b>NOTE:</b> The soundbar must be set up and connected to your Wi-Fi network using the Bose Music app.</p> <p>Connect your mobile device to Wi-Fi.</p> <p>Make sure you're in a country where Google Assistant is available.</p> <p>Make sure you are using the most up-to-date version of the Google Assistant app.</p> <p>Make sure the wake word is enabled (see page 25).</p> <p>Make sure your mobile device is compatible.</p> <p>Remove Google Assistant from the soundbar using the Bose Music app. Add Google Assistant again.</p> <p>Choose Pandora or Spotify as your default audio service (see page 27).</p> <p>Make sure you use the same audio service account on the Bose Music app and Google Assistant app.</p> <p>Google Assistant may not support your request. New features are added periodically.</p> <p>For additional support, visit:  <a href="https://support.google.com/assistant">https://support.google.com/assistant</a></p>
<p><b>Change your Google Assistant personal result settings</b></p>	<p>To turn off personal results or change the account for personal results, use the Settings menu in the Google Assistant app.</p>

SYMPTOM	SOLUTION
<p><b>Alexa doesn't respond</b></p>	<p>Make sure the Microphone off light is not glowing red. To turn on the microphone, see page 29.</p> <p>Make sure Alexa has been set up using the Bose Music app (see page 24).</p> <p><b>NOTE:</b> The soundbar must be set up and connected to your Wi-Fi network using the Bose Music app.</p> <p>Connect your mobile device to Wi-Fi.</p> <p>Make sure you're in a country where Amazon Alexa is available.</p> <p>Make sure you are using the most up-to-date version of the Amazon Alexa app.</p> <p>Make sure your mobile device is compatible.</p> <p>Make sure the wake word is enabled (see page 28).</p> <p>Remove Alexa from the soundbar using the Bose Music app. Add Alexa again.</p> <p>Make sure you say the name you assigned in the Bose Music app. If multiple soundbars have the same name, use the name assigned in the Alexa app or change the name in the Bose Music app.</p> <p>If using Voice4Video™:</p> <ul style="list-style-type: none"> <li>• Make sure there are no obstructions between the soundbar, your TV, and/or cable or satellite box.</li> <li>• Make sure the soundbar is connected using your HDMI cable (see page 55).</li> <li>• Make sure you have set up this feature using the Bose Music app and connected your TV and/or cable or satellite box.</li> <li>• Make sure you have entered your postal code and service provider for your cable/satellite box.</li> </ul> <p>Alexa may not support your request. New features are added periodically.</p> <p>For additional support, visit:  <a href="https://www.amazon.com/usealexa">https://www.amazon.com/usealexa</a></p>
<p><b>Soundbar doesn't connect to a Bose SoundLink Bluetooth speaker or Bose Noise Cancelling Headphones 700</b></p>	<p>Make sure that your speaker or headphones are powered on, within 30 ft (9 m) of the soundbar, and ready to connect to another device. For more information, refer to your product owner's guide.</p>
<p><b>Soundbar doesn't reconnect to a previously-connected Bose SoundLink Bluetooth speaker</b></p>	<p>On your speaker, use the product controls to cycle through the product device list until you hear the name for your soundbar. For product-specific instructions, refer to your speaker owner's guide.</p>

SYMPTOM	SOLUTION
<b>Soundbar doesn't reconnect to previously-connected Bose Noise Cancelling Headphones 700</b>	Connect using the Bose Music app. You can access this option from the Settings menu.
<b>Delayed audio from a connected Bose SoundLink <i>Bluetooth</i> speaker or Bose Noise Cancelling Headphones 700</b>	<p>Not all Bose SoundLink <i>Bluetooth</i> speakers can play audio in perfect sync when connected to the soundbar. To check if your product is compatible, visit: <a href="https://worldwide.bose.com/Support/Groups">worldwide.bose.com/Support/Groups</a></p> <p>Install any available software updates for your speaker or headphones. To check for updates, open the appropriate Bose app for your product on your mobile device or visit <a href="https://btu.bose.com">btu.bose.com</a> on your computer.</p>

## RESET THE SOUNDBAR

Factory reset clears all source, volume, and network settings from the soundbar and returns it to original factory settings.

1. On the remote, press and hold the Volume down button — and Play/Pause button ▶|| for 5 seconds until the light bar pulses white twice then fades to black.



The soundbar reboots. When the reset is complete, the light bar glows solid amber.

2. To restore the soundbar's network and audio settings:
  - a. Launch the Bose Music app on your mobile device and add the soundbar to your network (see "Add the soundbar to an existing account" on page 17).
  - b. If the soundbar is mounted on the wall, adjust audio for wall mounting (see page 14).

## CONNECTION OPTIONS

Connect the soundbar to your TV using one of the following connection options:

- **Option 1:** HDMI ARC (not provided)
- **Option 2:** Optical

**NOTE:** Using your TV's HDMI ARC (Audio Return Channel) port allows you to use your TV remote to control the power, volume, and mute functions of the soundbar.

1. On the back of your TV, locate the **HDMI IN** and **Audio OUT** (optical) ports.

**NOTE:** Your TV port panel may not appear as shown. Look for the shape of the port.

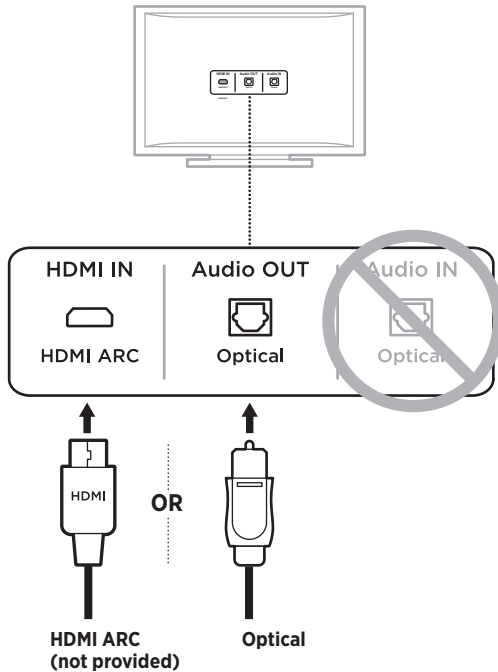

2. Choose an audio cable.

## CONNECT THE SOUNDBAR TO YOUR TV

After choosing an audio cable, connect the soundbar to your TV.

### Option 1: HDMI ARC (not provided)

1. Insert one end of your HDMI cable into your TV's **HDMI ARC** port.

**NOTE:** Make sure you insert the HDMI cable into an HDMI ARC port on your TV, not a standard HDMI port. If your TV doesn't have an HDMI ARC port, see page 56.

2. Insert the other end of the cable into the **HDMI (ARC)** port on the soundbar.

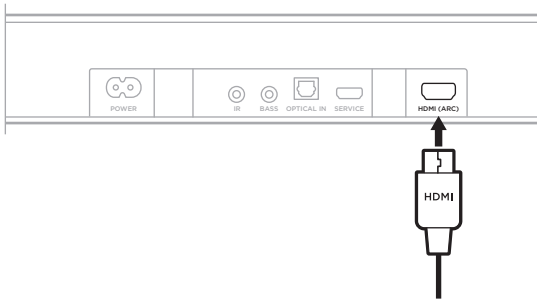

## Option 2: Optical

If your TV doesn't have an HDMI ARC port, use the optical cable to connect the soundbar to your TV.

1. Remove the protective cap from both ends of the optical cable.

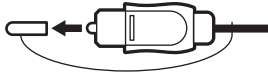

**CAUTION:** Inserting the plug with the cap attached can damage the plug and/or the port.

2. Insert one end of the optical cable into your TV's **Optical OUT** port.

**CAUTION:** Inserting the plug with the wrong orientation can damage the plug and/or the port.

3. Hold the plug at the other end of the optical cable.
4. Align the plug with the soundbar's **OPTICAL IN** port and insert the plug carefully.

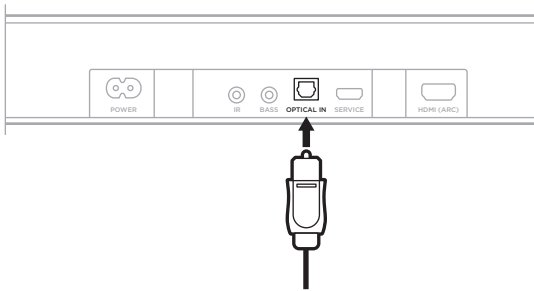

**NOTE:** The port has a hinged door that swings inward when inserting the plug.

5. Firmly push the plug into the port until you hear or feel a click.





## CHECK FOR SOUND

**NOTE:** To avoid hearing distorted audio, turn off your TV speakers. Refer to your TV owner's guide for more information.

1. Power on your TV.
2. If you are using a cable/satellite box or other secondary source:
  - a. Power on this source.
  - b. Select the appropriate TV input.
3. Power on the soundbar (see page 19).

You hear sound coming from the soundbar.
4. On the soundbar remote, press the Mute button .
- You don't hear sound coming from the TV speakers or soundbar.

**NOTE:** If you don't hear sound coming from the soundbar or hear sound coming from your TV speakers, see "Troubleshooting" on page 45.



858459-0010